

## **PicoPacket Technical Reference Manual**

PacComm Packet Radio Systems, Inc.  
4413 N. Hesperides Street  
Tampa, FL 33614-7618

Telephone: (813) 874-2980  
Facsimile: (813) 872-8696

Orders: (800) 486-7388

1  
2  
3  
4  
5  
6  
7  
8  
9  
10  
11  
12  
13  
14  
15  
16  
17  
18  
19  
20  
21  
22  
23  
24  
25  
26  
27  
28  
29  
30  
31  
32  
33  
34  
35  
36  
37  
38  
39  
40  
41  
42  
43  
44  
45  
46  
47  
48  
49  
50  
51  
52  
53  
54  
55  
56  
57  
58  
59  
60  
61  
62  
63  
64  
65  
66  
67  
68  
69  
70  
71  
72  
73  
74  
75  
76  
77  
78  
79  
80  
81  
82  
83  
84  
85  
86  
87  
88  
89  
90  
91  
92  
93  
94  
95  
96  
97  
98  
99  
100

---

---

---

This entire manual is Copyright © 1996 by  
PacComm Packet Radio Systems, Inc.  
**ALL RIGHTS RESERVED**

Reproduction or translation of any part of this work beyond that permitted by Sections 107 or 108 of the 1976 United States Copyright Act (or its legal successor) without the express permission of the copyright owner is unlawful. Requests for permission to copy or for further information should be addressed to PacComm Packet Radio Systems, Inc.

**Second Edition (Revised), October 1996**

---

---

## Table of Contents

|  |    |
|--|----|
| PacComm Warranties .....   | 4  |
| Repair Service .....   | 4  |
| United States Federal Communications Commission (FCC) Notice ..... | 5  |
| Introduction .....   | 6  |
| About This Manual .....  | 6  |
| PicoPacket Features .....  | 6  |
| Network Firmware Compatibility .....                               | 7  |
| PicoPacket Firmware .....  | 7  |
| PicoPacket Models .....  | 8  |
| PicoPacket Summary .....   | 8  |
| Quick Start .....  | 9  |
| Firmware .....   | 9  |
| Baud Rates .....   | 9  |
| Computer Connection .....  | 9  |
| Radio Connection .....   | 9  |
| Power .....  | 10 |
| Software Requirements .....  | 10 |
| PacComm Firmware Support .....                                     | 10 |
| APRS Quick Start .....   | 11 |
| GPS Receiver Operation .....                                       | 13 |
| If You Have Problems .....   | 13 |
| Hardware Description .....   | 24 |
| Design Considerations .....  | 24 |
| Modem Specifications .....   | 24 |
| RS-232-1 Serial Port .....   | 24 |
| PicoPacket Block Diagram .....                                     | 26 |
| Detailed Circuit Description .....                                 | 26 |
| Oscillator .....   | 26 |
| CPU Complex .....  | 26 |
| Serial Port .....  | 26 |
| Serial Port Signal Definitions .....                               | 27 |
| HDLC .....   | 29 |
| Watchdog Timer .....   | 29 |
| Battery Backed RAM (bbRAM) PicoPacket Rev. 1.1 and 1.2 .....       | 29 |
| Battery Backed RAM (bbRAM) PicoPacket Rev. 1.31 .....              | 29 |
| Power Supply PicoPacket Rev. 1.1 and 1.2 .....                     | 29 |
| Power Supply PicoPacket Rev. 1.31 .....                            | 29 |
| Modem Transmit .....   | 30 |
| Modem Receive .....  | 30 |
| Troubleshooting .....  | 30 |
| General Tests .....  | 30 |
| Digital Troubleshooting Techniques .....                           | 31 |
| General Cautions .....   | 31 |

|   |    |
|---|----|
| Power Supply .....                                      | 31 |
| Typical Problems .....                                  | 32 |
| <i>PicoPacket appears dead</i> .....                    | 32 |
| <i>The PicoPacket prints only gibberish</i> .....       | 34 |
| <i>Uncopyable transmitted or received packets</i> ..... | 34 |
| <i>Can't get enough modem output</i> .....              | 34 |
| <i>DCD LED constantly flickers on and off</i> .....     | 34 |
| <i>Modem won't key transmitter</i> .....                | 35 |
| <i>Transmitter locks in key down condition</i> .....    | 35 |

## **PacComm Warranties**

---

PacComm Packet Radio Systems, Inc. (PacComm) warrants amateur products to be free from defects in materials and workmanship for a period of one year from the date of purchase by the retail customer. During the warranty period, PacComm will, at its option, repair, replace, or refund the purchase price of any unit that it determines to be defective. This warranty does not apply to any product which has been modified, damaged through carelessness, misuse or neglect, used in commercial service or which has been repaired outside PacComm facilities without permission. Consequential damages are not covered. PacComm will refund the purchase price (less shipping charges) for units returned within thirty days of purchase. Returned units are subject to a restocking fee if not in like-new condition or if significant customer support has been rendered during the trial period.

PacComm Packet Radio Systems makes no representation of warranties with respect to the contents hereof and specifically disclaims any implied warranties of merchantability or fitness for any particular purpose. Further, PacComm Packet Radio Systems reserves the right to revise this publication, hardware, and software, and to make changes in the content hereof without obligation of PacComm Packet Radio Systems to notify any person of such revisions or changes.

## **Repair Service**

---

PacComm provides a rapid, low cost repair service for our products, whether in or out of warranty. Carefully pack the unit and send it to the PacComm address with a written description of the problems experienced and the repair service desired. Normal service turnaround is under five days. We stock all parts for our units.

**Warning:** The firmware contained in all PacComm EPROMs is copyright by PacComm and may not be copied for any purpose.

## United States Federal Communications Commission (FCC) Notice

---

The FCC places limits on the strength of non-intentional signals emitted by electronic accessories which attach to, or install in, personal computers. These computer peripherals are classified as Class B Computing Devices. The following notice is required by United States Regulations.

### THE FCC WANTS YOU TO KNOW:

This equipment has been tested and found to comply with the limits for a Class B computing device, pursuant to Part 15 of FCC Rules. These limits are designed to provide reasonable protection against such interference in a residential installation. This equipment generates, uses and can radiate radio frequency energy and, if not installed and used in accordance with the instructions, may cause harmful interference to radio communications. However, there is no guarantee that interference will not occur in a particular installation. If this equipment does cause interference to radio or television reception, which can be determined by turning the equipment off and on, the user is encouraged to try to correct the interference by one or more of the following measures:

- Reorient or relocate the receiving antenna.
- Increase the separation between the equipment and receiver.
- Connect the equipment into an outlet on a circuit different from that to which the receiver is connected.
- Consult the dealer or an experienced radio/TV technician for help.

You are also warned, that any changes to this certified device will void your legal right to operate it. All interface cables to and from this device must be shielded.

End of required message.

---

## Introduction

---

### About This Manual

---

This manual applies to the PacComm PicoPacket Packet Controller. It covers the physical, electrical, and mechanical aspects of the PicoPacket. Instructions for operating the PicoPacket firmware are contained in the Operating Manual for PacComm Packet Controllers.

Be sure to read any Errata before operating the PicoPacket.

A Quick Start section is provided following this introduction to assist experienced operators in PicoPacket operation.

The Jumper and Solder Pad Section has a full technical explanation of the function and default setting of each jumper and solder pad.

A full schematic and circuit description are provided to assist technically sophisticated users to make the best use of PicoPacket features.

The terms "computer" and "terminal" are used interchangeably to refer to the device used to communicate with the packet controller.

### PicoPacket Features

---

The PicoPacket uses modern surface mount technology for compact size and excellent performance and value.

- "TAPR" style commands plus many PacComm additions.
- On-Line HELP makes this the perfect beginner's TNC. So easy to learn!
- The PacComm Personal Message System (PMS). A self-contained message system (mailbox) with all the state-of-the-art features. About 12k storage is available in the 32k model, over 64k storage in 128k model.
- Terminal programs for both DOS and Windows™ included.
- GPS ready. Full support for APRS (the Automatic Position Reporting System) with either single or dual port models. The PicoPacket works with APRS through either the standard single serial port or the optional second serial port. The PicoPacket and APRS work together so that when the PicoPacket with a GPS receiver (internal or external) is controlled by APRS it sends no beacons except as commanded by APRS. When the APRS computer is disconnected, the PicoPacket automatically becomes a "tracker" sending out location beacons at specified intervals.
- Comes with Instruction Manual, schematic, Quick Command listing, RS-232 cable and DE-9S adapter, two unterminated radio cables, and power cord.
  - RJ-45 radio cable is made of "real" copper wire and solders easily to radio connectors.



## Introduction

---

- Optional full-time GPS port (second serial port) also provides real-time clock and 128k RAM.
- Internal GPS. A Trimble SVee6-CM3 GPS Receiver is fitted directly into the PicoPacket.
- Battery Pack model. Built-in charger, and a case back with rails to carry the slide-on/slide-off battery pack.
- 10MHz rated CMOS Z-181 (80181) macro-cell MPU.
  - Z-80 compatible CPU.
  - 8530 SCC HDLC port.
  - Two asynchronous serial UART ports.
  - GPS Power management functions.
- 32k or 128k battery backed RAM. (512k RAM on special order).
- EPROM and RAM are socketed for ease in upgrading firmware and increasing memory.
- Crystal controlled IC modem supports standard 1200/2200Hz tones used for 1200 baud AFSK packet.
- Connect, Status, PTT, and Carrier Detect LEDs.
- Black anodized aluminum case 1 x 2.5 x 3.25 inches.
  - All metal construction is resistant to electronic emanations.
- Hardware clock support standard on all Internal GPS and Second Serial Port Models.
- Open Squelch DCD circuit built in to every PicoPacket.
- Typical power Consumption 50mA @ 8-14 VDC. Power saving features reduce the average current draw significantly.

## Network Firmware Compatibility

---

The PicoPacket is not intended for network use. No provisions have been made to accommodate currently available network firmware. **The PicoPacket is NOT TNC-2 compatible.**

## PicoPacket Firmware

---

PacComm firmware is based on code licensed from Tucson Amateur Packet Radio Corp. (TAPR).

PacComm firmware supports most TAPR commands, but internally it is much, much different than TAPR code. There are many additional commands and features and we are continually expanding the functionality of the code.

In addition, the PacComm code has been extensively re-written for faster execution and greater reliability.

---

**PicoPacket Models**

---

The PicoPacket is offered in several different models. These models are manufactured from the same circuit board design, but the case and components fitted are not the same.

---

**PicoPacket Models**

---

- PicoPacket Standard Model w/32K RAM/Open Squelch DCD
- PicoPacket Standard Model w/128K RAM/Open Squelch DCD
- PicoPacket w/Battery Pack/32K RAM/Open Squelch DCD
- PicoPacket w/Battery Pack/128K RAM/Open Squelch DCD
- PicoPacket w/2nd Serial Port/Real Time Clock/128K RAM/Open Squelch DCD
- PicoPacket w/Battery Pack/2nd Serial Port/Real Time Clock/128K RAM/Open Squelch DCD
- PicoPacket w/Internal GPS/2nd Serial Port/Real Time Clock/128K RAM/Open Squelch DCD
- PicoPacket w/Internal GPS/Battery Pack/2nd Serial Port/Real Time Clock/128K RAM/Open Squelch DCD

---

**PicoPacket Summary**

---

The PacComm PicoPacket is a compact, robust, and inexpensive packet controller. The modern surface mount technology used in the PicoPacket design provides durability and ensures many years of reliable service. The Battery Pack, 2nd Serial Port, Open Squelch DCD, and full GPS support options provide flexibility, allowing the PicoPacket to be tailored to the specific needs of the individual.

## Quick Start

---

---

### Firmware

---

The PicoPacket is provided with PacComm's TAPR based TNC firmware. The commands are fully documented in the Operating Manual for PacComm Packet Controllers and are provided in concise form on the Command Reference Card.

New to packet, or an old timer who has forgotten a few commands? Just type Help followed by a command name (or part of a command name) and receive the correct spelling, shortest abbreviation, default value(s), acceptable value(s), and a short explanation of its function.

### Baud Rates

---

PicoPacket baud rates are set by the BAUD command. Rates from 300 to 9600 (9.6kb) are selectable for the terminal. The PicoPacket serial port baud rate is defaulted to 9600 bps. The radio port is set at 1200 bps and may not be altered.

To change the data rates, type BAUD at the command prompt (cmd:) and press the letter corresponding to the data rate desired. If you want the new rate to take effect immediately, type 'X'. Immediately change the data rate of the terminal or communication program to match. If you want the new data rate to take effect after the RESTART command is given, type 'Z'.

### Computer Connection

---

The PicoPacket RS-232 connector is wired as DCE. The RS-232 cable should be wired for connection from a computer (DTE) to a modem (DCE). The cable and adapter supplied with the PicoPacket should connect directly to a standard pinout PC serial port without modification. To connect to a 25 pin connector, use a pre-made adapter or see the Serial Port interfacing section of this manual (Page 16).

### Radio Connection

---

The PicoPacket allows the transmit signal to be applied directly to the microphone and draws received audio from the radio's speaker connection. The PicoPacket should easily interface to any voice grade radio.

Radio connector pinout is on page 17.

## **Power**

---

The PicoPacket operates from a nominal 6 VDC. Input voltage may range from 6.0 to 14.5 volts. The center pin of the power receptacle is positive. A diode protects the PicoPacket from reversed polarity power connections. The power consumption of the PicoPacket Standard Model is approximately 50 mA.

## **Software Requirements**

---

The PicoPacket is supplied with both DOS and Windows™ communication programs.

The Windows™ program is a demonstration version of the excellent packet terminal program, **PacketPet for Windows™**, which is sold by PacComm.

The DOS program is a public domain program which is simple and easy to use.

If you are not using a PC, any software that enables your computer to operate with an ordinary telephone modem should work for testing and operating your PicoPacket.

The PacComm telephone BBS [(813) 874-3078] has a variety of programs which may be downloaded at no charge. Also check your local packet radio BBS, local telephone BBS, public domain software vendors in computer magazines, at hamfests, computer shows, and local flea markets.

## **PacComm Firmware Support**

---

PacComm welcomes problem reports when our firmware does not appear to function properly. Call, fax, or write for a software discrepancy form which will help you record all the information necessary for us to research the problem.

PacComm supports the current firmware release, and the most recent prior release for a period of six months after it has been superseded.

Bug reports on earlier releases are solicited, but the bug fixes will only be applied to the current release. PacComm policy is to constantly improve the performance and features of our firmware, but to limit the frequency of firmware releases to a modest rate.

---

**APRS Quick Start**

---

The PicoPacket is fully APRS (Automatic Position Reporting System) compatible. The following features and commands have been added to the PicoPacket to enhance APRS support.

- The **MONitor** command remains operative when GPS is set to ON; i.e. the monitor function is on or off depending on the setting of MON regardless of whether GPS is on or off.
- The **MYAlias** command allows the assignment of an alternative callsign (in addition to the callsign specified in **MYCALL**) for digipeater use. The PicoPacket firmware includes the **MYAlias** command along with three additional callsign alias fields; **MY1alias**, **MY2alias**, and **MY3alias**. The additional callsign alias fields function like the **MYAlias** command.
- The **LTEXT** serves as a buffer to contain the most current data string from the attached GPS or LORAN receiver. The **GPSTEXT** command (see *Operating Manual for PacComm Packet Controllers*) specifies which string is automatically entered into the **LTEXT**. The PicoPacket firmware includes three additional text buffers, **L1text**, **L2text**, and **L3text**, which operate like **LTEXT**. The **L1text**, **L2text**, and **L3text** allow you to place supplementary data strings (i.e. NMEA, weather text, etc.) in these fields, in addition to the data string automatically placed in the **LTEXT** (usually \$GPGGA). When the PicoPacket sees the character specified in the **LGtchar** command it dumps the contents of the **LTEXT**, **L1text**, **L2text**, and **L3text** fields to the terminal.
- **LG1text**, **LG2text**, and **LG3text** are fields to be used for generating a history file in the Personal Message System. These fields are not yet operative but have been set aside for inclusion in a future firmware release.
- **ELOc** (Echo Location) is an ON/OFF command. When **ELO** is OFF, the **LOCATION** beacon operates as described in the Operating Instructions. When **ELO** is ON, it causes the current contents of the Location Text field (**LTEXT**) to be sent out the serial port (RS-232 or RS-232-1) as ASCII text instead of being sent out the radio port as a beacon. The timing is controlled by the **LOCATION** command, just as for the beacon. This command is useful when you desire to locally view the GPS output at a specified interval.
- The **LGtchar** command selects the character used to trigger the dumping of the contents of the **LTEXT**, **L1TEXT**, **L2TEXT**, and **L3TEXT** fields to the terminal. The default value of the **LGtchar** is \$00 which disables this function. **LGtchar** should be set to \$05 for use with APRS Release 74d and later. This command eliminates the need for a serial port splitter cable when used with the two-port PicoPacket.

When the LGEtchar is set to any value other than \$00, the TNC watches for the specified character in the serial port input stream (RS-232-1 on the two-port PicoPacket). When this character is detected, it is discarded from the data stream, and the contents (if NOT blank) of the four LTEXT fields are dumped to the serial port and the "current cycle" of the LOCATION timer is sent as if a LOCATION beacon had just been sent. If APRS queries the PicoPacket with the LGEtchar intermittently (sometimes more, sometimes less than the LOCATION timer) then the PicoPacket will also send the LOCATION beacons intermittently.

This supports the "F8" function key in APRS which requests the latest fix from the attached GPS. It allows automatic conversion from an APRS tracker (which is the TNC emitting location beacons) to an APRS mobile (which is a computer emitting location beacons via a TNC). If you plug in an APRS computer which is configured correctly to work with the PicoPacket, the TNC is preempted from sending location beacons until the computer is disconnected.

The LGEtchar command should be left set to \$00 on PicoPacket models without a second serial port or an internal GPS receiver. Note that the LGEtchar command will work in Transparent mode, but transparency is LOST, since the LGE character is deleted from the outgoing data stream

- The **GPS** command. On single port PicoPacket models, the GPS command operates as specified in the Operating Manual. On PicoPacket models with a Second Serial Port or Internal GPS, the GPS functions are always active. The GPS command selects which port is used as input for the GPS data, using the computer port as reference; e.g. GPS OFF (normal setting) expects GPS data from the second serial port (RS-232-2 or internal GPS), while GPS ON expects GPS data from the primary serial port (RS-232-1).
- Note that "GPS data" does not have to be from a GPS receiver and may actually be data from a weather station or other telemetry device.
- PicoPacket firmware responds to the **?APRS?** query by sending a location beacon. This occurs at a random time between 10 and 150 seconds after **?APRS?** is heard (as the first characters in a data packet).

---

## **GPS Receiver Operation**

---

PacComm has been successfully integrating GPS technology into packet controllers for several years, the insight gained from this experience has been incorporated into the PicoPacket design. An Internal GPS receiver is offered as an option on the PicoPacket, and the PicoPacket with Second Serial Port Model accepts GPS information as input into the second serial port. This section will attempt to give an overview of GPS receiver operation to those unfamiliar with this exciting technology that is making it's way into the world of packet radio.

Those new to the use of the Global Positioning System will notice that it sometimes takes longer than other to get a fix. Let's look at why sometimes fixes appear relatively quickly, and sometimes they do not.

First, the GPS receiver is exactly that - a receiver, and as a receiver it must rely on information gleaned from satellites to do it's job. It starts out not knowing where on earth it is. After about 28 seconds it will know from any ONE of the available satellites what the date and time is. It will then search around trying each one of the satellite codes (there are 24 ) in an attempt to get good signals from FOUR satellites. This may take several minutes in this first attempt. The receiver may derive a fix rapidly, BUT do not switch off the receiver, as it has not assimilated all the data it needs.

The GPS receiver relies on the satellites to furnish it with an ALMANAC which it stores in RAM. It takes a full 15 minutes to receive the ALMANAC. This allows the receiver (once it knows the time and date) to predict which satellites are going to be visible to it the next time it is powered up. Some fine tuning detail, called the ephemeris, is also downloaded and stored in the receiver's RAM. The NEXT time the receiver is turned on, if the satellite signals are good, it will obtain a fix much faster than when initially used. Subsequent warm starts should take between 30 seconds and 4 minutes to obtain a fix, depending on system geometry. However, if the receiver has moved significantly over the ground while the unit was switched off (more than 300 miles) or has lost RAM battery back-up, the almanac will incorrectly predict the satellites in view and will possibly panic after a few minutes and go into the full sky search routine described above.

---

## **If You Have Problems**

---

If you do not succeed in getting your PicoPacket packet controller operating with this Quick Start section then you should read the Operating Manual and all of the Technical Reference Manual for more detailed information.

Please make an effort to research the problem in the manuals which are provided before telephoning for assistance. Many customers telephone for technical support only to find their question is clearly answered in the manual.

## Quick Start

If you call for technical assistance, have the following information ready:

1. The model name or number of the packet controller you are using, e.g. PicoPacket w/Second Serial Port or PicoPacket w/Internal GPS Receiver, etc.
2. Details about the computer you are using, such as:
  - The communications program you are using.
  - Accessory cards installed in your computer.
  - The number of pins on your serial port connector.
3. Details about the radio you are using, such as:
  - Brand and model number.
  - Type of radio interface cable being used.
4. The current jumper and solder pad settings on the PicoPacket board and any daughter boards.



---

## Installation and Operation

---

This section provides information about the radio selection, switches, connectors, LEDs, jumper settings, and adjustments of the PicoPacket packet controller.

### Radio Interface

---

The modem in the PicoPacket is designed for connection to the microphone and speaker/headphone connections of a radio. Signal connections required to the radio are Transmit Audio to the microphone, Receive Audio direct from the receiver, PTT (radio keying) and Ground.

A resistive PTT connection is provided for use with many hand held radios. This R-PTT output simplifies connecting a PicoPacket to hand held radios (which typically have a combined mic input and keying line) by routing the PTT signal through a 2.7k resistor and placing this output on a separate pin of the RJ-45 radio connector (J3).

### Switches, LEDs, and Connectors

---

#### Power Switch

---

The first generation of the PicoPacket (Rev. 1.1) has no power switch. Plug in the power plug to turn the unit on; remove the power plug to turn the Pico off.

PicoPacket Revs. 1.2 and later have a two position power switch. The position closest to the Output Adjust trimpot is off, and the position closest to the edge of the cabinet is on.

PicoPacket Battery Pack models (Revs. 1.2 and later) use a three position power switch. The position closest to the Output Adjust trimpot is for battery charging, the center position is off, and the position closest to the edge of the cabinet is on.

#### LEDs

##### CON

The Connect LED (CON) illuminates when an AX.25 connection exists on the selected stream for that port. (See multi-connection explanation in the Operating Manual).

##### STA

The Status LED (STA) illuminates whenever an AX.25 frame has been sent but not yet acknowledged. If a connection is to be terminated (DISCONNECTED) and the STA LED is lit, some frames which were sent but not acknowledged may be lost. The STA LED will blink at about a 1 Hz rate if there is an unread message in the Personal Message System (PMS).

**PTT**

The Push To Talk LED (PTT) illuminates whenever the PicoPacket activates the radio keying line.

**DCD**

The Data Carrier Detect LED (DCD) illuminates when the modem senses a packet signal of the proper baud rate. The LED may occasionally flicker due to noise on the radio circuit.

**Internal Connectors**

**J2 and P3**

J2 and P3 are expansion connectors used to support a daughterboard implementing such features as the second serial port, real time clock, and internal GPS receiver.

**External Connectors**

Every PicoPacket is provided with two unterminated radio cables, a power connector with attached cable, and an RS-232 cable with DE-9 adapter.

**Power Connector**

The power connector is a 1.3 mm diameter coaxial type. The sleeve is negative and the center pin is positive. Extra power connectors are available at electronic or audio equipment stores or from PacComm.

Use caution when attaching a strange 'wall-transformer' power supply to the PicoPacket. Many power supplies are wired with the sleeve positive and center pin negative.

**P1 - RS-232 Serial Port Connector**

The PicoPacket RS-232 computer connector is an RJ-45-6 female connector wired as a modem (DCE). See the Serial Port section for more information (Page 16).

**Pin 1 - Clear to Send (CTS)**

RS-232 level flow control signal **out** of the PicoPacket. Indicates whether the TNC is allowing or holding-off data input on pin 3.

**Pin 2 - Receive Data (RXD)**

Receive Data (RXD) RS-232 level data **OUT** OF the PicoPacket to the terminal.

**Pin 3 - Transmit Data (TXD)**

RS-232 level data **INTO** the PicoPacket from the terminal.

**Pin 4 - Request to Send (RTS)**

RS-232 level flow control signal **into** the PicoPacket. Indicates the attached computer wants to send data to the TNC.

**Pin 5 - Ground**

Pin-out for both RJ-45 Connectors-Looking into the sockets on the PicoPacket.

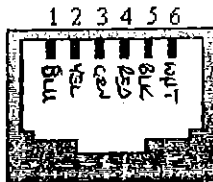

Combined signal and frame ground.

**Pin 6 - N/C or DCD**

On the first generation PicoPacket (Rev. 1.1) this pin is not connected. On subsequent versions (Rev. 1.2 and later) this pin provides a signal to the DTE (terminal) that the modem is connected to another station (on-line).

**Note:** DSR and DTR lines are not implemented on the PicoPacket. If your computer requires a DSR signal to operate properly, tie pin 4 of the DE-9 adapter to pin 6 inside the adapter housing.

**J2 Radio Connector**

Connections to the radio are made via J2, a RJ-45-6 receptacle.

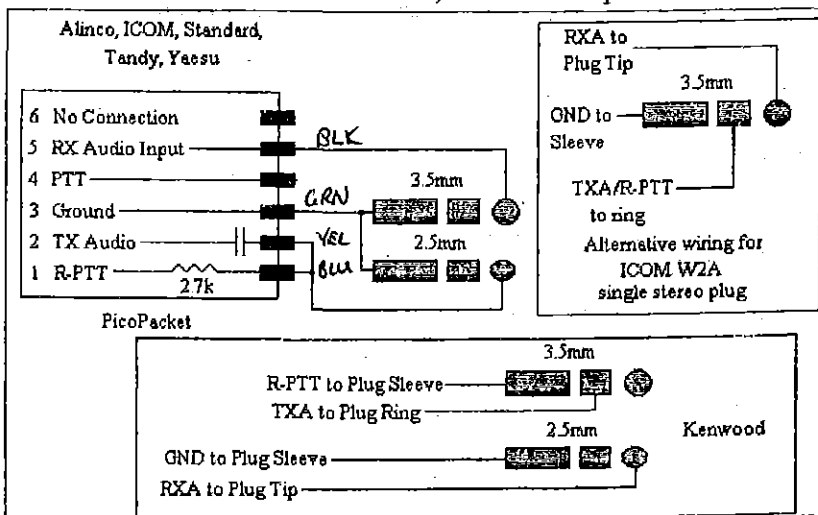

**Pin 1 - Resistive PTT**

This line is connected internally to the PTT line by a 2700 ohm resistor simplify connecting to hand held radios. The circuit for connecting to such a radio is shown above. Note that both the capacitor and resistor are provided **INSIDE** the PicoPacket. To key a conventional radio attach the radio PTT line to PicoPacket pin 4.

**Pin 2 - Transmit Audio**

The modem output which connects to the radio microphone input. Adjust output level with VR3 through the opening in the PicoPacket rear panel.

**Pin 3 - Ground**

Ground line for both signal and chassis ground.

**Pin 4 - PTT Signal**

Connect to the radio PTT line. Uses open drain keying which assumes the keying line in the radio is pulled-up to a positive voltage

**Pin 5 - Receive Audio**

Signal input from radio speaker or headphone jack.

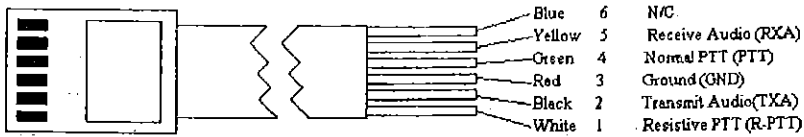

### RS-232-2 (Second Serial Port)

An additional RS-232 port is provided on PicoPacket Models with the Second Serial Port Option. The second serial port is accessed via a 3.5mm stereo jack labeled RS-232-2. The connections to the mating plug are as shown. A schematic of the cable is provided on the rear of the PicoPacket schematic.

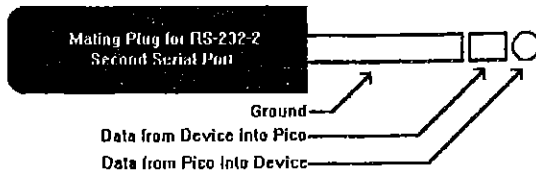

The second serial port allows for an external GPS or weather station to be attached to the PicoPacket.

## Adjustments

### Modem Adjustments

#### Audio Input Level

The PicoPacket modem requires from 25 to 700 millivolts audio input. For normal operation, the level of output provided by the FM receiver should be adjusted to a low to medium level. There is no input level adjustment on the PicoPacket Revs. 1.2 and earlier. On the PicoPacket Rev. 1.31 an Audio Input Impedance jumper (JPRA) has been included. If JPRA is open a 47k resistor (R16) is placed in the line for high impedance audio input, if JPRA is closed this resistor is bypassed for speaker audio input. If desired, adjust the radio's output audio level to approximately 50 mV with the aid of a high impedance voltmeter or oscilloscope.

#### Transmit Level

Use the following procedure:  
Connect the PicoPacket and radio, turn on the PicoPacket and computer and start the computer communications program.

1. Enter the command CAL <<CR>> and the letters "KD" to cause the PicoPacket to key the radio with a steady dual tone.

**NOTE:** The watchdog timer will cause the PTT circuit to reset after approximately 60 seconds. Type 'K' <<CR>> to restart the procedure. The tones may be checked individually by typing 'K' instead of 'KD' in the procedure above. Pressing the space bar will switch to the opposite tone. The output level is set by adjusting trimpot VR3 which is accessible through the rear panel opening marked Output Adjust.

2. With the PicoPacket keying the transmitter adjust the transmit audio level trimpot VR3 while observing a service monitor or deviation meter tuned to the transmitting frequency. Set the deviation for 2.8 to 3.5 kHz.
3. Type the command Q to unkey the transmitter.

**NOTE:** Too low is better than too high a drive level. A high drive level causes over-deviation, unnecessary interference, and makes the signal less copyable. Running 5 kHz deviation, for example, can result in a loss of 6 to 20 dB in signal to noise performance on the circuit.

#### Modem Receive Bias Adjustment

You should not adjust these trimpots unless advised to do so by factory technical support personnel.

**NOTE:** The diagram below describes the PicoPacket Rev. 1.31. On the first and second generation PicoPacket (Revs. 1.1 and 1.2) the designator and function of the trimpots remains the same as the PicoPacket Rev. 1.31, however their location is reversed.

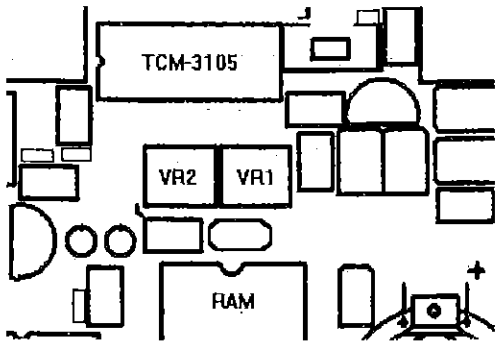

Trimpot VR1 is the modem bias adjustment. The procedure below is used at the factory. While observing pin 11 of the 3105 modem IC (U2) adjust VR1 to give a reading of 2.65 to 2.70 vdc on should produce satisfactory results.

#### Carrier Detect Level Adjustment

Use an oscilloscope or voltmeter to monitor the signal level on pin 14 of the TCM3105 modem IC. With no input signal present adjust VR2 to give a 'low' TTL signal. Set VR2 to the point just below the transition to a 'high' level. Confirm that the state of pin 14 goes high when an input signal is applied to the PicoPacket. If the required equipment is not available, adjust trimpot VR2 to cause the DCD LED to illuminate when a weak input signal is present to the modem, and to go out when no signal is present.

The above carrier detect level adjustment is for PicoPacket models without the Open Squech DCD circuit. Ensure that the solder pad SP7 is jumpered from 2-3 to use the modem (TCM-3105) carrier detect.

**Carrier Detect Level Adjustment for Open Squelch DCD Models**

**Note:** The Carrier Detect Level Adjustment for PicoPackets with the Open Squelch DCD circuit installed is IN ADDITION TO the Carrier Detect Level Adjustment described above. Therefore to adjust the carrier detect level of a PicoPacket with the open squelch DCD circuit installed, you must first jumper solder pad SP7 from 2-3 and follow the procedures above to set the modem (TCM-3105) carrier detect. Then remove the solder bridge from pads 2-3 of the solder pad SP7 and jumper SP7 from 1-2, you are thus prepared to set the open squelch DCD carrier detect level. The solder pads SP19 and SP20 are used to adjust the carrier level detect when the XR2211 DCD circuit is installed. When the XR2211 circuit is installed, jumper SP20 closed and use a frequency counter to observe the output at Pin 3 of the XR2211. Adjust VR4 for an output at Pin 3 of 1700Hz. After completing the adjustment, jumper SP19 closed and open SP20.

**NOTE:** SP7 must be set to 1-2 if the XR2211 DCD circuit is installed. These solder pads are not available on the PicoPacket Rev. 1.1 and 1.2.

## Jumper and Solder Pad Definitions

Detailed jumper and solder pad definitions for all revisions of the PicoPacket, including options and factory default settings are described below.

### **JPB Back-up Battery** **Default: Closed**

Open Back-up battery disabled, RAM contents lost at power-off.

Closed Back-up battery enabled, RAM contents preserved.

JPB makes or breaks the battery back-up connection to the RAM which preserves RAM contents when power to the PicoPacket is off.

### **JPRA Audio Input Impedance** **Default: Closed**

Open High Impedance audio input.

Closed Speaker Audio input.

**NOTE:** This jumper is not available on the PicoPacket Rev. 1.1 and 1.2.

### **SPD DCD LED Input Select** **Default: 1-2**

This solder pad applies modern the DCD signal to the DCD LED. Do not change the default setting of SP3. This solder pad is not available on the PicoPacket Rev. 1.31.

### **SP1 RAM Size** **Default: see below**

1-2 32K RAM \*default for 32K RAM models

2-3 > 32K RAM \*default for RAM sizes greater than 32K

### **SP2 EPROM Size** **Default: see below**

1-2 32K EPROM (27C256)

2-3 Reserved for future use.

2-4 64K EPROM (27C512) \* default setting

### **SP3 Reverse Protection By-Pass** **Default: see below**

Open 1N4001 Diode (D6) installed \* default for Battery Pack Models

Closed D6 not installed \* default for ALL models EXCEPT Battery Pack Models

**NOTE:** This solder pad was referred to as the RXD Select jumper on PicoPacket Revs. 1.1 and 1.2. On those models SP3 should remain Open.

### **SP4 A19/Power Control Select** **Default: 2-3**

1-2 Applies control signal for GPS power management.

2-3 Applies A19 to adapter board for expanded memory.

### **SP5 D7 Bypass** **Default: Closed**

Open D7 installed for additional reverse power protection.

Closed D7 not installed.

**NOTE:** This solder pad was available on the PicoPacket Rev. 1.2 only.

### **SP6 U9 Reverse Protection Bypass** **Default: Open**

Open U9 installed (Battery Pack Models ONLY).

Closed U9 not installed.

**NOTE:** U9 is the 8 volt regulator used to charge the Battery Pack Models of the PicoPacket line. If a battery board is NOT installed, U9 should be vacant and SP6 should be closed. This solder pad is not available on the PicoPacket Rev. 1.1.

## PicoPacket Jumper and Solder Pad Definitions

| SP7 | DCD Selection                                | Default: 1-2 |
|-----|--|--------------|
| 1-2 | Open Squelch DCD (XR2211) circuit installed. |              |
| 2-3 | 3105 DCD (XR2211 NOT installed).             |              |

**NOTE:** This solder pad, and thus the XR2211 circuit is not available on the first generation PicoPacket (Rev. 1.1). On the PicoPacket Rev. 1.2 the XR2211 circuit was offered as an option and built on a daughter board. All models of the PicoPacket Rev. 1.3 include the XR2211 DCD circuit.

**SP19 / SP20 Carrier Detect Level Adjustments**      **Default: See Below**  
SP19 and SP20 are used to adjust the carrier detect level on PicoPackets with the Open Squelch DCD circuit installed. Refer to the Installation and Operation section of this manual for detailed instructions on the carrier detect adjustment.

**NOTE:** SP7 must be set to 2-3 if the XR2211 DCD circuit is installed. These solder pads are not available on the PicoPacket Rev. 1.1 and 1.2.

**SP8, SP9, SP11, SP12, SP13, SP14, SP15, SP16, SP17, SP18, and SP21 are not used on the PicoPacket. Do NOT change the factory defaults on these solderpad jumpers.**

The following solder pad jumpers are available on the GPS/MEM/RTC circuit board, which is a "daughter" board interfaced with certain models of the PicoPacket. The GPS/MEM/RTC board acts as an internal GPS carrier board, memory expansion board (512kb), provides real-time-clock features, and second serial port option. The GPS/MEM/RTC board is present on all second serial port and internal GPS models and it's configuration is model dependent.

| SPA    | Active Antenna Select        | Default: Open |
|--------|------------------------------|---------------|
| Open   | GPS requires passive antenna |               |
| Closed | GPS requires active antenna  |               |

**Note:** The Trimble SVee6-CM3 offered with the Internal GPS model of the PicoPacket requires an active antenna.

| SPV    | Auxiliary Power Select                             | Default: Open |
|--------|--|---------------|
| Open   | GPS/MEM/RTC board powered by 5vdc from PicoPacket. |               |
| Closed | PicoPacket powered by 5vdc from GPS/MEM/RTC board. |               |

**Note:** This solder pad is Closed for PicoPacket w/Internal GPS and Open for PicoPacket w/Second Serial Port models. This solder pad is available on the second generation and beyond of the GPS/MEM/RTC (Rev. 1.1 and later) circuit board.

| SP1 | LED Fix/Power Select                                      | Default: 2-3 |
|-----|---|--------------|
| 1-2 | LED D1 or D3 indicates power applied to unit              |              |
| 2-3 | LED D1 or D3 indicates GPS receiving 3 or more satellites |              |

**Note:** This solder pad is defaulted from 2-3 for PicoPacket w/Internal GPS and PicoPacket w/Second Serial Port models. This solder pad is available on the second generation and beyond of the GPS/MEM/RTC (Rev. 1.1 and later) circuit board.

| SP2    | Power Management Bypass                | Default: Closed |
|--------|--|-----------------|
| Open   | GPS power management features enabled  |                 |
| Closed | GPS power management features disabled |                 |



## PicoPacket Jumper and Solder Pad Definitions

**Note:** This solder pad is available on the third generation and beyond of the GPS/MEM/RTC (Revs. 1.2 and later) circuit board.

### **SP3 GPS Data Flow Control Default: 2-3**

- 1-2 GPS data routed to PicoPacket from internal GPS receiver.
- 2-3 GPS data routed to PicoPacket from external GPS receiver or other telemetry device.

**Note:** This solder pad **MUST** be used in conjunction with SP4. This solder pad is available on the third generation and beyond of the GPS/MEM/RTC (Revs. 1.2 and later) circuit board.

### **SP4 GPS Data Flow Control Default: 2-3**

- 1-2 GPS data routed to internal GPS from PicoPacket.
- 2-3 GPS data routed to external GPS or other telemetry device from PicoPacket.

**Note:** This solder pad **MUST** be used in conjunction with SP3. This solder pad is available on the third generation and beyond of the GPS/MEM/RTC (Revs. 1.2 and later) circuit board.

### **SP5 D2 Bypass Default: Open**

- Open PicoPacket w/2nd Serial Port Option
- Closed PicoPacket w/Internal GPS Option

**Note:** This solder pad is available on the fourth generation and beyond of the GPS/MEM/RTC (Revs. 1.3 and later) circuit board.

### **TTL1 TTL Level Select Default: Open**

- Open RS-232 level output at RS-232-2.
- Closed TTL level output at RS-232-2.

**Note:** This solder pad is available on the second generation and beyond of the GPS/MEM/RTC (Rev. 1.1 and later) circuit board. This solder pad **MUST** be used in conjunction with TTL2; e.g. they are either **BOTH** open or **BOTH** closed. If TTL levels are desired, **BOTH** TTL1 and TTL2 must be closed, and the MAX-232 chip (U1) must **NOT** be installed on the GPS/MEM/RTC board.

### **TTL2 TTL Level Select Default: Open**

- Open RS-232 level output at RS-232-2.
- Closed TTL level output at RS-232-2.

**Note:** This solder pad is available on the second generation and beyond of the GPS/MEM/RTC (Rev. 1.1 and later) circuit board. This solder pad **MUST** be used in conjunction with TTL1; e.g. they are either **BOTH** open or **BOTH** closed. If TTL levels are desired, **BOTH** TTL1 and TTL2 must be closed, and the MAX-232 chip (U1) must **NOT** be installed on the GPS/MEM/RTC board.

---

## Hardware Description

---

This section includes detailed hardware specifications and a functional description of the hardware design of the PicoPacket packet controller.

---

### Design Considerations

---

The PicoPacket incorporates a Z-181 microprocessor unit which provides enhanced feature capability while allowing backwards compatibility with the Z-80 CPU. This innovation permits PacComm to build upon existing firmware and provide additional features, such as:

- Larger memory mapping capabilities.
- 2 full-duplex UART serial ports.
- Low power consumption.
- Portable, lightweight design.
- Multi-layer printed circuit board to improve noise immunity.
- Surface mount technology allows for compact design without sacrificing reliability.
- Removable battery pack option.
- Full APRS (Automatic Position Reporting System) support.
- Internal or external GPS support options.

---

### Modem Specifications

---

The PicoPacket modem is a Bell 202 compliant AFSK design based on the Texas Instruments TCM3105. The chip uses switched capacitor filtering to achieve sharp filtering and noise immunity.

This same modem design has been used in tens of thousands of other PacComm TNCs. Tones of 1200 and 2200 Hz are used for standard amateur radio operation at 1200 baud.

---

### RS-232-1 Serial Port

---

The PicoPacket packet controller communicates with the computer or terminal through a serial port using RS-232 level signals.

The PacComm PicoPacket packet controller supports asynchronous computer terminal baud rates of 300 to 9600. The port supports standard parity options as well as 7- or 8-bit character lengths.

Factory settings are 9600 baud, eight bit word-length, no parity and one stop bit.

## Hardware Description

The serial port connector on the PicoPacket packet controller is on the front panel marked RS-232 or RS-232-1. The pins on the serial port connector of packet controller that must be connected are shown in the following table. This is commonly called a three-wire RS-232 cable.

### RS-232 Serial Port "3 Wire" Cable Wiring for DE-9 Computer

| <u>Computer DE-9</u> | <u>PicoPacket</u> |
|----------------------|-------------------|
| 5 and shell .....    | 5                 |
| 2.....               | 2                 |
| 3.....               | 3                 |

The packet controller is configured as Data Communications Equipment (DCE), the technical term for an RS-232C modem. Most computers and terminals are configured as Data Terminal Equipment (DTE).

Some computers require that Clear to Send (CTS) of the computer serial port connector (pin 5 of a DB-25 or pin 8 of a DE-9) be connected to an appropriate signal. Others may require connections for Data Carrier Detect (DCD) (pin 8/pin 1) and Data Terminal Ready (DTR) (pin 20/pin 4). To accomplish this on the PicoPacket jumper the computer's input and output signals on DB-25 pins 4/5 (DE-9 pins 7/8), and on DB-25 pins 6/8/20 (DE-9 pins 6/1/4) in addition to the connections shown in the "3 wire" RS-232 diagram above.

### Jumpering RTS/CTS and DTR/DSR/DCD at the Computer End



Computers with nonstandard RS-232 serial ports must meet the following conditions:

- Voltage levels sent by the computer must be greater than +3 volts in one state and less than -3 volts in the other state.
- The signal polarity must conform to the RS-232 standard, i.e. the low voltage state is a logical "1" and the high-voltage state is a logical "0".

Make or buy a cable that provides the following connections:

- The computer serial port common (ground) pin must be tied to the PicoPacket serial port connector pin 5.
- The signal line that sends data from the computer must be tied to the PicoPacket connector pin 3.
- The pin on which the computer receives data must be tied to the PicoPacket connector pin 2.

The documentation provided with the computer or its accessory serial port should clarify any requirements for additional signals.

## PicoPacket Block Diagram

A block diagram of the major PicoPacket functions is presented below.

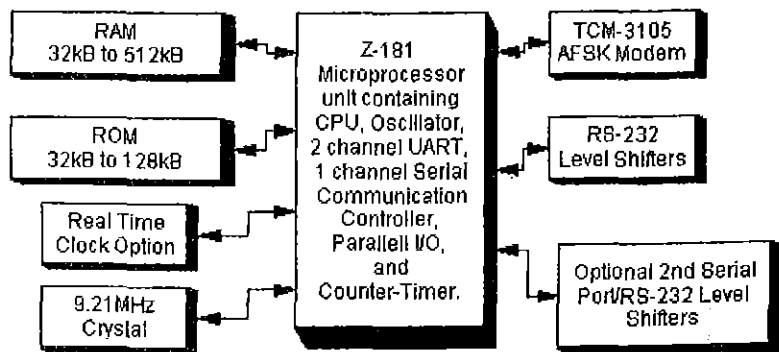

## Detailed Circuit Description

### Oscillator

A 9.21 MHz crystal is divided in two by the internal CPU oscillator to provide a stable 4.6 MHz CPU clock source.

### CPU Complex

The microprocessor, U1, is a CMOS Z-181(84180-10). Both asynchronous serial and HDLC functions are performed by U1.

The EPROM U7 (27C512; 64k bytes) contains all the firmware, addressed as two banks of 0 to 7FFF.

The 32k x 8 or 128k x 8 RAM, U6, holds all buffered data and battery backed parameters. RAM is addressed from 8000 to FFFF.

Each memory device's chip select is provided by the processor and the RAM chip select is also buffered by a power failure detection circuit. When voltage is low or removed, the RAM enters low power mode, drawing approximately two micro-amps while retaining memory contents.

### Serial Port

U1 provides for asynchronous communications through a RS232 driver and receiver (U5). RS232 signals are interfaced via an RJ-45-6 connector with a DCE pinout. Baud rates of 300, 1200, 2400, 4800, and 9600 are supported.

---

**Serial Port Signal Definitions**

---

This section describes the signals on the packet controller's serial port connector. Since the pins are defined with respect to the Data Terminal Equipment (DTE) (computer) end of the circuit, and the packet controller is wired as Data Communications Equipment (DCE) (modem), some standard pin names appear to be the reverse of the packet controller function. Read this section carefully if you are experiencing difficulty communicating with the PicoPacket via the serial port.

- **Frame Ground (FG)** is provided for attachment to the chassis of the packet controller and the chassis of the attached computer terminal. This is common to the signal ground on the PicoPacket.
- **Transmit Data (TXD)** is an input line to the packet controller on which the attached computer terminal device sends data.
- **Receive Data (RXD)** is an output line from the PicoPacket on which it sends data to the attached computer terminal device.
- **Request to Send (RTS)** is an input to the packet controller signaling that the attached computer terminal device is ready to accept data from the PicoPacket. This line is used for hardware flow control.
- **Clear To Send (CTS)** is an output from the packet controller signaling the attached computer terminal device to send data to the PicoPacket. This line is used for hardware flow control.
- **Signal Ground (SG)** is the common, or return, path for all signals between the PicoPacket and the attached computer terminal device. It is common with the frame ground.
- **DCD (Data Carrier Detect)** is an output from the packet controller signaling the attached computer that the PicoPacket is in a connected (on-line) state.

**Note:** DSR and DTR lines are not implemented on the PicoPacket. If your computer requires a DSR signal to operate properly, tie pin 4 of the DE-9 adapter to pin 6 inside the adapter housing.

The table below provides a cross reference to the pinouts of the standard 25 pin connector, the industry standard 9 pin connector as used on many computers and terminals, and the RJ-45, DE-9P, DE-9S, and DB-25S connectors used on PacComm products. Note that connecting a DTE device to a DCE device using either 25 pin connectors or 9 pin connectors at both ends of the cable provides a 'straight through' wiring of pin numbers, i.e. connect column 1 to column 4 **OR** connect column 2 to column 3. However, when a 25 pin connector and 9 pin connector are used on the same cable, i.e. column 1 to column 3, several pairs of signal lines must be crossed.

Hardware Description

**PicoPacket RS-232 Serial Port Signal Cross Reference**

|      | Conventional<br>25 Pin<br>Connector | Conventional<br>9 Pin<br>Connector | TINY-2<br>RS-232<br>DCE | PicoPacket<br>RS-232<br>DCE | SPIRIT-2<br>RS-232<br>DCE |
|------|-------------------------------------|------------------------------------|-------------------------|-----------------------------|---------------------------|
|      | DB-25P<br>Pin #                     | DE-9P<br>Pin #                     | DE-9P<br>Pin #          | RJ-45<br>Pin #              | DE-9S<br>Pin #            |
| FG   | 1                                   | shell                              | 5                       | 5                           | 5                         |
| TXD  | 2                                   | 3                                  | 3                       | 3                           | 3                         |
| RXD  | 3                                   | 2                                  | 2                       | 2                           | 2                         |
| RTS  | 4                                   | 7                                  | 7                       | 4                           | 7                         |
| CTS  | 5                                   | 8                                  | 8                       | 1                           | 8                         |
| DSR  | 6                                   | 6                                  | 6                       | -                           | 6                         |
| SG   | 7                                   | 5                                  | 5                       | 5                           | 5                         |
| DCD  | 8                                   | 1                                  | 1a                      | 6                           | 1a                        |
| Test | 9                                   | V+                                 | -                       | 6                           | -                         |
| Test | 10                                  | V-                                 | -                       | -                           | -                         |
| DTR  | 20                                  | 4                                  | n/c                     | -                           | n/c                       |
| RI   | 22                                  | 9                                  | 9b                      | -                           | 9b                        |

The CTS and RTS lines of the PicoPacket serial port (labeled P1 on the circuit board and RS-232 on the front panel) are used by the PicoPacket firmware for hardware "handshaking" to control the flow of data between the computer and the packet controller.

The computer terminal indicates it is ready to receive data from the PicoPacket by asserting its Request To Send (RTS) signal on P1 pin 4. The packet controller will send data when RTS is asserted (if there is data to be sent). If the computer is not ready to receive data, it negates (makes false) RTS to the PicoPacket. Thus, data flow from the packet controller to the computer is controlled by the use of the RTS line.

The packet controller asserts its Clear To Send (CTS) output, P1 pin 5, whenever it is ready to receive data from the computer. If the PicoPacket's buffers fill, it will negate CTS, signaling the computer to stop sending data. The packet controller will assert CTS when it is again ready to receive data from the computer. Thus, data flow from the computer to the packet controller is regulated by the use of the CTS line. The CTS line is always toggled, even if "software flow control" is enabled in this direction.

If "software flow control" is preferred, or if the computer terminal serial I/O port does not implement CTS/RTS and DTR/DSR handshaking, then a three wire cable should be used. If these RS-232 control lines are not connected they will be pulled up (and thus asserted) by resistors at the PicoPacket end and proper operation will result. However, a non-standard serial port may use some pins for other purposes,

## Hardware Description

such as supplying power to a peripheral device, so be sure that the system either implements the CTS, RTS and DSR handshake or has no connections to these pins of P1 whatsoever. Note that reference to RS-232C "compatibility" or the presence of a DB-25 or DE-9 type connector does not guarantee that you have a standard RS-232C serial port!

### **HDLC**

The HDLC function is performed by the Z-181 (U1) which communicates to the onboard integrated circuit modem to provide 1200 baud AFSK.

### **Watchdog Timer**

U1 (Z-181) RTSA (pin 56) provides the signal that ultimately keys the radio transmitter. When the PicoPacket is transmitting, RTSA goes low, which is fed through C6 to a Schmitt trigger gate (U3 pin 13) which turns on the PTT LED (D4) and returns a high signal to the gate of a VN10 (FET) transistor (Q). This high state on the VN10 gate causes it to conduct to ground, keying the transmitter. The RTSA low to C6 starts it charging through R4 to Vcc. If the RTSA signal remains low more than 60 seconds, C6 reaches the Schmitt trigger voltage, causing the gate (U3) to turn off the PTT LED and the VN10, thus unkeying the transmitter.

### **Battery Backed RAM (bbRAM) PicoPacket Rev. 1.1 and 1.2**

The entire 32K or 128K of RAM (U6) is backed up with a 3 volt lithium battery. The DS1210 (U4) is also battery powered keeping "chip enable" (Pin 22) of the RAM disabled (high) during periods of low power to the PicoPacket (typically 6.5 volts and below).

### **Battery Backed RAM (bbRAM) PicoPacket Rev. 1.31**

The entire 32K or 128K of RAM (U6) is backed up with a 3 volt lithium battery. "Chip Enable" (Pin 22) of the RAM is disabled (high) by U10B (74HC32) when VCC falls below 4.75V. When Vcc falls below 4.75 volts, the reset (Pin 1) output of the MC34064 (U4) goes low. This signal is used to disable the RAM "chip select" and to hold the CPU in a "reset" state until Vcc returns.

### **Power Supply PicoPacket Rev. 1.1 and 1.2**

The incoming positive voltage is routed through a diode (D8) for reverse polarity protection. It feeds regulator U8 (LM2931). The battery circuit is isolated by U4 (DS1210) to keep the RAM powered when-ever JPB is installed. The PicoPacket requires approximately 50 mA at 9-14 VDC.

### **Power Supply PicoPacket Rev. 1.31**

The incoming positive voltage is routed through a diode (D8) for reverse polarity protection. It feeds regulator U8 (LM2931). The battery circuit is isolated by D7 and

## Hardware Description

---

D10 (1N5819) to keep the RAM powered whenever JPB is installed. The PicoPacket requires approximately 50 mA at 9-14 VDC.

### Modem Transmit

---

Data to be transmitted is coupled directly from the CPU pin 54 to the modem chip. The modem output tones are AC coupled to the output level trimpot (VR3) and shunted by Q2 when in the receive state.

### Modem Receive

---

Received audio (RA) is AC coupled straight into the modem chip and the recovered data are fed to the CPU.

The modem audio input impedance is approximately 50k ohms on the PicoPacket Rev. 1.1 and 1.2. The modem audio input impedance is approximately 50k ohms or 500 ohms depending on the setting of jumper JPRA on the PicoPacket Rev. 1.31.

## Troubleshooting

---

---

The PacComm PicoPacket packet controller/modem is a complex piece of electronic equipment. Servicing must be approached in a logical manner. The best preparation for troubleshooting is to study the detailed hardware description above and the commands in the Operating Manual. Many suspected faults can be traced to improper parameter settings. This section of the manual will give direction to troubleshooting based on PacComm's engineering and customer support experience.

### General Tests

---

The PicoPacket packet modem operates as part of a system which also includes a radio, computer or other data source, interconnecting cables and a similar setup at the other end of the circuit. The first step is to make sure that the PicoPacket is the source of the problem being experienced. The primary cause of non-communication between sites is RF problems and the most usual cause of the appearance of a "dead" PicoPacket is cabling related. Inspect the interconnection cabling. Does it work on another controller or RS-232 device? Has the radio and/or computer been successfully used on packet with this or another PicoPacket? Will the packet modem at the 'other end' of the circuit operate correctly?

The PicoPacket has status LEDs which are powerful tools in troubleshooting. Careful attention to the LED patterns will reveal much about the quality of the RF link as well as the general health of the PicoPacket.



---

**Digital Troubleshooting Techniques**

---

**WARNING: Never remove or insert an IC with power turned on!**

---

**General Cautions**

---

The PicoPacket circuit board is a multi-layer type to reduce noise and interference. Improper removal of integrated circuits or other components could damage the circuit board and cause loss of continuity from internal traces. Be very careful of the small surface mount traces and pads.

**Power Supply**

---

The first thing to check in any malfunction is the power supply. Check the power supply levels at the output of the voltage regulators. Are they close to their nominal values?

**U8 Pin 1 +5VDC +/- 0.2**

Do all the ICs in the suspected area have the proper voltage on their power pins? Is there excessive ripple in any of the DC voltage lines? If so, check the regulator and associated components, working backwards toward the input power. If the voltage is low, in conjunction with a hot regulator, suspect a short circuit on the board.

Inspect all solder joints for a smooth shiny appearance. A dull gray appearance may be an indication of a crystallized solder joint. Use a small soldering iron designed for printed circuit work and resolder the connection. Remember that all the logic circuits operate at standard TTL levels (a "low" is less than plus 0.4 V and a "high" is greater than plus 2.4 volts), and all digital inputs and outputs switch between these two levels. Thus, if logic signals are switching between 0 and, say, 1 volt, there is a problem (usually a short). On the other hand, do not mistake switching transients on digital logic lines for improper operation --- these show up as ringing and other distortions.

Verify that there is activity on the control bus READ (U6 Pin 24) and WRITE (U6 Pin 29) lines, the CHIP SELECT lines on the memory (U6 Pin 22), and the IORQ line on the CPU (U1 Pin 84). Each of these lines should show activity, and if any line is quiet this is a sign of trouble. Address and data line problems may also show up as lack of activity on the control bus lines, especially the chip selects. Check each of the 16 address (U6 Pins 1-12, 23, 25-28, 30, and 31) and 8 data lines (U6 Pins 13-15 and 17-21) for activity. Any lines showing a lack of activity are not operating properly.

If there is reason to suspect problems with address or data lines, try removing the memory chip. Each address and data line will now show a distinct pattern. The address lines should be (possibly distorted) square waves whose periods increase by a factor of two on successive lines as line by line checking is done from A0 to A19.

## Hardware Description

Logic lines that show no activity may often be traced to a short on the printed circuit board, probably due to a defective solder joint. Follow the instructions above for inspecting solder joints. If an ohmmeter is used to check for shorted lines, use a low voltage/low current test instrument. (Most modern DVMs are fine for this.) If in doubt, remove any ICs connected to the lines being measured. If a short is suspected, check the high density areas of the PC board for the problem. In most cases the short will be found there.

Oscilloscope waveforms may reveal circuit board problems. A 'stair-case' waveform on two different pins indicates they are probably shorted together. Also, square waves of half amplitude, or lines with no activity are dead giveaways on the scope. If an oscilloscope is not available, then a voltmeter can be helpful in finding serious difficulty on digital signal and address lines.

Set the meter for the scale where a full 5 volts can be displayed. A reading of 1.5 to 3.5 volts indicates some varying digital signal. A reading of over 3.5 volts or under 1.5 volts is most likely an indication of trouble. A very low, or very high voltage reading is a sign of no activity, or open and shorted circuits. If the trouble cannot be located using this set of guidelines, then either obtain an oscilloscope, or send the board back to PacComm for repair. Be very careful about shorting pins on ICs when applying meter or scope probes to the board. It is a good idea to attach a secure ground lead to the meter or scope, one that won't accidentally short across components on the board. Avoid connecting in the area where power leads run.

Do not try to unsolder an IC which is soldered directly into the circuit board as permanent damage the circuit board may result. If troubleshooting points to a failed IC which is soldered into the board, clip each lead of the IC, remove the body of the IC, and then individually remove each IC pin.

### Typical Problems

**Re-read the manual regarding jumper settings and cable connections. The following analyses will assume that all jumpers are properly set.**

#### *PicoPacket appears dead*

If no LEDs wink during the reset cycle, check to see that the crystal oscillator is working (9.21MHz) and that the signal appears at U1 pin 93. The clock signal is a (possibly distorted) square wave. Check with a good oscilloscope and a 10:1 probe.

Verify that the battery backed-up RAM protection circuit is working by checking that pin 32 of a 128k RAM (U6) is going to at least plus 4.7 volts after input power is applied.

## Hardware Description

If the PicoPacket powers up with the CON LED lit, followed by the CON LED extinguishing a second or so later, the processor is working and the software is probably working correctly. An overall check of the processor, memory, and may be conducted using the **HEALTH** command in the standard TNC firmware (see Operating Manual.)

If the PicoPacket won't sign on to the computer, observe pin 10 of U5, the MAX 232 with an oscilloscope and cycle the Pico-Packet power switch. Transitions on this pin shortly after reset indicate that the PicoPacket is sending data. If no signal transitions are seen, recheck that the CPU appears to be operating (see below.) If data appears to be present, verify that transitions are also present on U5 pin 7.

If the above checks are OK, use an oscilloscope to verify that data is present on U5 (Max 232) pin 13 and pin 12 when a key is pressed on the computer. If not, the data isn't getting from the computer to the PicoPacket. Check J4, the cable and U5 again. Finally, be sure that the computer actually uses levels less than -3 volts and greater than +3 volts for signal levels. 0 and +5 volts will not work.

A quick check of the serial port may be accomplished by the following procedure. Connect a power source to the PicoPacket and an oscilloscope (or voltmeter on a 15 volt scale) to pin 2 of the RS-232 connector. Do not connect any computer or radio cables. Turn on the PicoPacket. Observe the LEDs. If the PicoPacket powers up with the PWR, CON and STA LEDs lit, followed by the CON and STA LEDs extinguishing a second or so later, and the scope or voltmeter shows a lot of activity for about 1/2 second, the PicoPacket digital section is operating and sending a sign-on message out the serial port.

If the above LED tests prove successful, but there is no activity displayed on the screen of the computer terminal, the following test may prove helpful. First, confirm that baud rate settings on the terminal/communication software and PicoPacket are matched. Just after powering on the PicoPacket, give the command **HEAL Y**. If the PicoPacket is correctly receiving characters from the terminal, the CON and STA LEDs will begin flashing. The command **HEAL N** will stop the flashing. This test will verify if the communication problem is only in the direction from the PicoPacket to the terminal.

**NOTE:** The primary cause of non-communication between the PicoPacket and the computer is improper cabling setup.

Inspect the interconnection cabling. Does it work on another controller or RS-232 device? Has the radio and/or computer been successfully used on packet with this or another PicoPacket? Are all the connections tight? Has the cable frayed or broken?

## Hardware Description

---

If the PicoPacket won't send data to the computer, verify that the CTS line at J4 pin 1 is not being held low. If the software flow control option is disabled, the PicoPacket will not send data to the computer unless its RTS is asserted. If the computer does not implement the RTS/CTS protocol, the RTS/CTS lines (pins 4 and 1 on J4) should remain unconnected.

Positive and negative RS232 output levels are provided by U5. Check for +10VDC at U5 pin 2 and -10VDC at U5 pin 6 with a voltmeter. Readings should be within one volt. If these readings are good and the PicoPacket accepts commands but displays nothing at the terminal, then the RS-232 driver, U5 is most likely at fault. If voltages are not correct, check U5 and associated circuitry.

### ***The PicoPacket prints only gibberish***

---

This indicates that some combination of the data rate (baud rate), parity option, or number of start and stop bits are not set the same at the PicoPacket and at the computer. Also verify that the computer is set for eight data bits, no parity, and 1 stop bit. These are the default sign-on settings stored in the EPROM. Perform a hard reset by removing and replacing the power. The sign on message should appear.

If the PicoPacket's sign-on message lines appear to be typed over each other, set **AUTOLF ON**. If the sign-on message appears to be double-spaced, set **AUTOLF OFF**. If the sign-on message appears to be single-spaced, **AUTOLF** is set correctly.

### ***Uncopyable transmitted or received packets***

---

If no other station seems to be able to decode the packet transmissions, it is possible that the transmitter is being overdriven or underdriven. The solution may be to adjust the radio drive level via the trimpot, VR3.

Check modem bias level at pin 11 of U2 with a voltmeter should be 2.7 VDC. If incorrect, adjust VR1 for proper voltage.

### ***Can't get enough modem output***

---

Disconnect radio cable and measure the modem output driving a 500 ohm load. If adequate output voltage is available in this test, check for shorts or miswiring of radio cable.

### ***DCD LED constantly flickers on and off***

---

If the flickering only occurs with the signal cable connected, be sure that shielded signal cable is being used, and that the audio drive level from the radio is not excessive. Adjust carrier detect level (see Installation and Operation section of this manual).

---

***Modem won't key transmitter***

---

If the transmitter doesn't key, the problem is most likely in the connecting cable. If the connections appear to be in order, check U1 (Z-181) pin 56 for keying (PTT) transitions. If nothing is seen on pin 56, either software or digital hardware are faulty. If pin 56 is active, trace the signal through the U3 (74HC14) pin 13 inverting at pin 12 to the gate of the keying FET(Q1). The FET output line changes from high impedance to low when a keying signal is present. Verify with an ohmmeter connected from J3 pin 4 to ground.

---

***Transmitter locks in key down condition***

---

The PicoPacket is protected against PTT malfunction by a watchdog timer on the keying line. However, if unshielded, improperly grounded cabling is used to feed the transmitter key line, and other signal cables, RF energy can get back into the PicoPacket and lock-up the keying transistor. Precautions are especially necessary if a high power amplifier is being used and there is a strong RF field in the area of the PicoPacket.

1  
2  
3  
4  
5  
6  
7  
8  
9  
10  
11  
12  
13  
14  
15  
16  
17  
18  
19  
20  
21  
22  
23  
24  
25

Operating Manual  
for  
PacComm Packet Controllers

**PacComm Packet Radio Systems, Inc.**  
4413 N. Hesperides Street  
Tampa, FL 33614-7618 USA

**Telephone: (813) 874-2980**  
**Fax: (813) 872-8696**  
**e-mail: [sales@paccomm.com](mailto:sales@paccomm.com)**  
**<http://www.paccomm.com>**

Copyright © 2000 by PacComm Packet Radio Systems, Inc.

**ALL RIGHTS RESERVED**

Reproduction or translation of any part of this work beyond that permitted by Sections 107 or 108 of the 1976 United States Copyright Act (or its legal successor) without the express permission of the copyright owner is unlawful. Requests for permission to copy or for further information should be addressed to PacComm Packet Radio Systems, Inc.

**Edition 7.2, January 2000**

**Contents**

---

|                                |     |
|--------------------------------|-----|
| Introduction                   | 3   |
| Quick Start Guide              | 5   |
| Packet Controller Command List | 10  |
| Packet Controller Messages     | 78  |
| Tutorial                       | 87  |
| Protocol                       | 127 |



## **Introduction**

---

The purpose of the PacComm packet controller is to act as an interface between ordinary voice radios, such as VHF or UHF FM transceivers for some models, a HF transceiver, and a computer. The packet controller will establish error-free radio communications between your computer and another packet-radio-equipped station. You will be able to have a "private channel" while sharing a frequency with other packet stations, operate a remote computer "bulletin board" or "electronic mail" stations, send messages, in short, to enjoy all the advantages of digital communication via your radio system.

## **About This Manual**

---

This Operating Manual explains how the packet controller operates and contains a detailed description of the commands the packet controller will accept and messages it may report, as well as a description of packet radio protocol(s).

This manual and other PacComm documents are written to apply to the entire line of PacComm products, and may contain descriptions of commands and features not included in every model.

The QUICK START chapter contains the basic information needed for an initial tryout of the packet controller.

The Packet Controller Commands chapter contains:

- A listing of the basic command set needed for packet operation.
- A single page overview of all packet controller commands grouped by function as they appear in the Command Listing.
- An alphabetical index of all packet controller commands in the Command Listing.
- The Command Listing contains a detailed description of each command, its parameters and default values, and examples of command use.

The Packet Controller Messages chapter explains all command, status, and error messages.

The Packet Tutorial chapter provides a comprehensive tutorial on packet operation and detailed descriptions of all of the packet controller features and functions.

The Packet Radio Protocol Chapter explains in detail how the AX.25 protocol operates.

## **Other Documentation**

---

Each PacComm packet controller is supplied with a TECHNICAL REFERENCE MANUAL. This may be bound into the rear of the Operating Manual or bound separately. Refer to the Technical Reference Manual for details on interfacing your packet controller to specific computers and radios and for details about the specific hardware features of the packet controller.

**Please be sure to read the ERRATA and SOFTWARE RELEASE NOTES that accompany your manual and packet controller. These documents will describe changes and upgrades made to your unit, which may not be noted in the other documents.**

The COMMAND REFERENCE CARD contains a listing of packet controller commands with a summary of parameters and a one line explanation of each command in a convenient form for reference while you are operating.

## **Terms Defined**

---

The term "packet controller" is the term most commonly used to refer to the PacComm equipment throughout this manual. Other terms sometimes used are terminal node controller (TNC), packet assembler/disassembler (PAD), packet modem, packet interface, etc.

The terms computer, computer terminal, and terminal are used interchangeably to refer to the computer or terminal which is connected to the packet controller.

## **Disclaimers**

---

The information contained in this document has been carefully checked and is believed to be entirely correct, however, no responsibility is assumed for inaccuracies. PacComm reserves the right to change products or documentation for any purpose including improvement of reliability and functionality without obligation to purchasers of previous equipment. PacComm assumes no liability arising out of the application or use of any product or circuit described herein; neither does it convey any license under its patent rights or the rights of others.

**NOTES:** The packet controller must be installed and operated in accordance with the printed procedures and should NOT be used for any purpose which involves the safety of life or limb. Careful connection of the unit to power sources and radio and computer equipment will insure that no hazardous situation is created through the interconnection. Carefully ground all units to a solid earth ground.

## Quick Start Guide

---

### Hookup and Test

---

1. Attach a data cable from the TNC to your computer or dumb terminal.
  - Attach using cable as defined in reference manual (easiest is 9 pin to 9 pin on PC).
  - Try using "5 wire cable" cable and hardware handshake if possible. This means Transmit Data (TXD), Receive Data (RXD), Request to Send (RTS), Clear to Send (CTS) and Ground (GND) are connected.
2. Connect to a regulated source of +12vdc to the packet controller.
3. Load a communications program on your PC and set the software .
  - Parity: NONE
  - Data bits: 8
  - Stop bits: 1
  - COM port: the one to which the TNC is attached.
  - Baud rate: the same as the packet controller, generally 1200 or 9600. On GPS equipped units, the rate is 4800.
4. Turn the packet controller on. A log-on message should appear in plain language followed by cmd:

If nothing appears or the display is unreadable:

- Double check the baud rate setting on your computer program.
  - The cable TX and RX data lines may be wrong or possibly CTS or RTS.
  - Check the "NORMAL EPROM/AUX EPROM" switch on the back of the packet controller is in the NORMAL (IN) position. Not all models have this switch.
  - If gibberish is produced the terminal settings are wrong.
5. Type in MY your-callsign e.g. MY WIBEL to set your unique ID.
    - Every command is followed by pressing the return key.

If you did this correctly, the packet controller will respond with WAS NOCALL and another command prompt (cmd:).

6. Prepare and attach the radio cable per the instruction manual (observe the correct order of pins in DIN connectors).
7. Turn on the radio and tune to a local packet channel.

- Open the squelch and advance the audio control until a reasonable listening level is heard, then close the squelch (unless hardware DCD option is fitted).
8. The DCD LED should come on when packets are received and packets begin to print on the screen.

Listen to the audio and feed it to the TNC at the same time, if you can.

Look on the screen for decoded packets. When you have a good correlation between most frames being heard (or the DCD LED coming on) and seen on the screen, you know that the volume setting, etc. is OK.

Some frames contain different protocols and will not be decoded. If you are curious, you may want to see the PIDCHECK command.

9. Type MHEARD and return. This will show you a list of stations you just heard. It gets up-dated each time a packet comes in.

### **Establishing a Packet Contact**

---

10. Try to connect to one of the stations as follows:

- Connect callsign e.g. C KB4AAA and press return.
  - ⇒ Either upper case or lower case is OK for commands.
- If all is well, the PTT LED on the TNC should light briefly and the radio should be keyed up.
  - ⇒ If the radio doesn't key up, you have a radio cable problem.
- If the unit transmits OK, but no connection occurs look for two problems:
  - ⇒ Transmit audio may be set too high or too low. If you have another receiver available, compare the volume of other people's packets to yours. Adjust the TX level control at the rear of the packet controller.
  - ⇒ If this fails to cure the problem, try adjusting the TXD parameter. Make it gradually larger until a connection occurs. (Note: Normally 50 - 100mV).

When you connect to a station you will see a different response depending upon what type of station is out there. They may be a REAL person (!) (talk directly keyboard to keyboard), a NODE (responds with a command line if return is tapped) for connecting forwards to other stations, a BBS (messaging system which will ask you various questions) or a DX-cluster (similar to a BBS, but gives real-time DX information).

## **Additional Notes**

---

- You need only to become familiar with a few commands to operate packet. See the Beginning Packet Operation chapter for basic packet information.
- Until you read the manual more fully, stick to Command & Converse Modes. You can exit Converse Mode by holding down CTRL and C on the keyboard. You may re-enter Converse Mode by using the letter K.
- You only need to enter the underlined portion of a command, but you may type the entire command if you desire.
- The packet controller has FIVE modes: command (talk to the TNC itself), converse (for talking to people/machines), transparent (special mode for data/file transfers), KISS mode (for advanced protocol use), and GPS mode for use with a Global Positioning System receiver.
- Always use the Disconnect command to finish a connection with a station (this command doesn't need a callsign).
- Some specialized programs such as NOS (for TCP/IP networking) and PB/PG (for satellites) use the KISS mode without you knowing it. If the program crashes, the TNC may be left in the KISS mode and appear dead.
- In case of being totally lost, type RESET and the TNC will go back to how it came out of the box. You must then reconfigure the TNC.

Some other points to remember - packet can be a complex and confusing subject. Take it a little at a time and don't get too frustrated. Ask for help, you can get it. Get a good packet book. You have a lot to learn - it won't all happen in one day! Good luck and have fun with your TNC. Remember this is for your enjoyment. If you do something wrong nobody will mind and you can always "pull the plug" and come back later!

## **A Deeper Look**

---

### **Software Requirements**

Any software that enables your computer to operate with an ordinary telephone modem should work with your packet controller.

PacComm offers for sale an excellent packet terminal program, **PacketPet for Windows** for use on a PC running Windows.

Check your local packet radio Bulletin Board System (BBS), local

telephone BBS, Public Domain software vendors in computer magazines, Hamfests, computer shows and local flea markets.

### **Computer Interfacing**

The packet controller communicates with your computer through a serial port using RS-232C signal levels. Some PacComm models also support 'TTL' level signals to interface to the Commodore VIC-20, C-64 and C-128 without requiring the use of an RS-232 adapter.

Serial port connector(s) are on the rear panel of the packet controller. Most PacComm models use a 9 pin EIA connector type DE-9 labeled "RS-232." If a pre-made cable is not provided with your packet controller, purchase or build a cable that connects to the serial port connector of your computer and the RS-232 (or TTL) connector of your packet controller. PacComm supplies the interface cables for some models, or the mating connectors for the packet controller connectors.

The RS-232 cable should be wired for connection from a computer (Data Termination Equipment - DTE) to a modem (Data Communication Equipment - DCE). See the Technical Reference Manual for detailed computer interfacing information for specific packet controller models.

### **Radio Interfacing**

#### **1200 Baud AFSK**

The packet controller was designed to allow hookup and testing to be done without any modifications to the radio. The packet controller's audio signals are fed directly into the microphone connector or similar auxiliary jack of the radio, and the packet controller output is adjusted to give a proper modulation level. The receiver's audio is taken from an auxiliary audio output or speaker jack on the radio and fed directly to the packet controller. Refer to the Technical Reference Manual for detailed instructions.

#### **9600 Baud and Higher DFM**

The packet controller was designed to make higher speed communication possible. As a result it is NOT possible for these units to connect to the microphone and speaker connections.

The transmit signal is applied directly to the varactor and the receive signal is taken directly from the discriminator. Some radios sold as '9600 baud ready' bring these connections out to a connector, however most radios require some amount of modification. Consult the Technical Reference Manual for further information.

## **If You Have Problems**

If you do not succeed in getting your packet controller operating with this Quick Start Chapter then you should read the Operating Manual and Technical Reference Manual for more detailed information. Please don't call for technical assistance if you haven't made an effort to research the problem in the manuals which are provided. Many customers telephone for technical support only to be embarrassed because their question is clearly answered in the manual and they haven't done their homework.

If you call for technical assistance, have the following information ready:

1. The model name or number of the packet controller you are using.
2. Details about the computer you are using, such as:
  - The communication program you are using.
  - Accessory cards installed in your computer.
  - The number of pins on your serial port connector.
3. Details about the radio you are using, such as:
  - Brand and model number.
  - Type of radio interface cable used.

## Packet Controller Commands

The packet controller commands are listed in alphabetical order.

### Presentation Conventions

| <u>C</u> OMMAND | Argument(s) | Default: |
|-----------------|-------------|----------|
|-----------------|-------------|----------|

|              |
|--------------|
| Parameter(s) |
|--------------|

Packet controller message to operator or user.

#### *Operator or user input*

#### NOTE:

The command name is printed with some letters underlined. These letters form the minimum abbreviation that you may use and still have your packet controller understand the command.

For example, the command MYCALL may be specified by simply typing MY. The abbreviation M is not sufficient ( and will be interpreted as a different command), but MY, MYC, MYCA, or MYCALL are all acceptable.

If a command requires parameters; they are shown in a box below the command name.

For commands that set values, the packet controller assumes a “most often used” or default condition. The defaults are the values stored in the EPROM which are loaded into RAM when the system is first powered up, or when you give the RESET command. Immediate commands perform actions rather than setting values, and don’t have defaults. An asterisk (\*) after the default value means the default may vary among models.

There are several types of parameters. Some parameters can have only one of two values, such as ON and OFF or EVERY and AFTER. If a parameter must be one of two values, the choices are shown separated by a vertical bar. You may use YES instead of ON and NO instead of OFF for typing convenience.

A parameter designated as “n” is a numeric value. These values may be entered as ordinary decimal numbers, or as hexadecimal (hex) numbers by preceding the number with a \$ symbol. When the packet controller shows some of these numeric parameters (those which set special characters), they will be given in hexadecimal. The numbers 10 through 15 are denoted by the hexadecimal digits A through F.



A parameter designated as text, such as the argument to CTEXT, may be entered in upper or lower case, and may include numbers, spaces, and punctuation. The text is accepted exactly as typed by the user.

Several commands require callsigns as parameters. They may be any collection of numbers and at least one letter up to six characters; they are used to identify stations sending and receiving packets. A callsign may additionally include a sub-station ID (SSID), which is a decimal number from 0 to 15 used to distinguish two or more stations on the air with the same call (such as a base station and a repeater). The callsign and SSID are entered and displayed as call-n, e.g., KOPFX-3. If the SSID is not entered, it is set to 0 and not displayed.

Some commands have parameters that are actually lists of items. For example, you may specify up to eight callsigns to be monitored with the command LCALLS. The second and later items in the list are optional and may be separated with commas or blank spaces.

**BEACON**      Every|After n

The command BEACON requires an argument which must be either EVERY or AFTER (abbreviated E or A), and an argument "n" which the user may choose from a range of values. An acceptable command might be B E 2.

**CONNECT**      call#1 [VIA call#2, [,call#3,...,call#9]]

The CONNECT command requires a callsign argument call#1. You may optionally include the keyword VIA, followed by a list of one to eight callsigns, call#2 through call#9. The callsigns in the list, if included, must be separated by commas (as shown) , or by blank spaces. An acceptable command might be C N2WX V AD7I WB9FLW. You can see the current value of the command's arguments by typing the command name by itself, without any argument(s).

**IMPORTANT NOTE:** This manual contains a comprehensive listing of PacComm firmware commands. Not all of these commands are implemented in each firmware release and in each product. Some commands are hardware related and have no applicability to a particular product, or are not necessary for the intended purpose of the product.

*Optional commands are preceded by the symbol •. Commercial firmware commands not in amateur versions are preceded by ♦. The DISPLAY command may also be used to show the available commands. Finally, any command which is not implemented will return a response of :*

? unknown command      or      not implemented

## Alphabetical Command List

### ? or H(ELP)

This command is used by an "over-the-air" PMS user. The HELP or ? command displays a list of PMS commands with a brief explanation of each.

**B(bye)**            **B[CR]** disconnects you from PMS  
**H(help)**           **H[CR]** or **?[CR]** displays this help file  
**J(log)**            **J[CR]** displays a list of callsigns heard with date/time  
**K(ill)**            **K n [CR]** deletes message n (only to/from your callsign)  
**KM**                **KM [CR]** kills all messages to your callsign  
**L(ist)**            **L [CR]** lists the 10 latest messages  
**M(ine)**           **M [CR]** lists the 10 latest messages to/from your callsign  
**R(ead)**            **R n [CR]** reads message number n  
**S(end)**            **S (callsign) (@BBS callsign) [CR]** begins a message addressed to (callsign) at home BBS of (@ BBS callsign)  
                          **Subject:** maximum 70 characters ending with [CR]  
                          **Text:** end each line with [CR]. End message by typing /ex[CR] or CNTL-Z[CR] at the beginning of a new line.

**SB**                Send bulletin  
**SP**                Send message marked Personal.  
**SR n**             Send reply to message number n.  
**ST**                Send message in NTS format.  
**V(ersion)**       **V[CR]** displays the software version of the PMS system.

### ?APRS?

The ?APRS? function is not an operator command. When the TNC receives a frame with a data field consisting of ?APRS? it will transmit the GPS capture buffers (LTEXT etc.) as if the LOCATION command had been invoked after a random time delay of up to two minutes.

### 3RDPARTY    ON|OFF or Yes|No                    Default: ON

|     |  |                   |
|-----|--|-------------------|
| ON  | -Allows messages to any callsign.                      | *Default may vary |
| OFF | -Allows messages to be addressed only to/ from MYPCALL |                   |

Selects whether PMS messages are accepted to other than MYPCALL.

When 3RDPARTY is ON, over-the-air messages may be addressed to any valid callsign. Use this setting if you want users to leave mail for each other. Use this setting if you want only user message traffic to your callsign.

If 3RDPARTY is OFF, an attempt to leave a message to a different callsign will result in the following message being sent:

**No third party mail allowed**

The sysop may address messages to any callsign regardless of 3RDPARTY.

**8BITCONV ON|OFF or Yes|No Default: ON**

ON -The high-order bit is not stripped in Converse Mode.

OFF -The high-order bit is stripped in Converse Mode.

If 8BITCONV is OFF, the high-order bit (bit 7) of characters received from the terminal is removed before the characters are transmitted in a packet. The standard ASCII character set requires only 7 bits and the final bit is used as a parity bit or ignored.

If you need to transmit 8-bit data, but don't want all the features of Transparent Mode, you should set 8BITCONV ON and AWLEN 8 . This may be useful if you are using a special non-ASCII character set.

Bit 7 is always removed in Command Mode, because commands require only the standard 7-bit ASCII character set.

**ACKPRIOR ON|OFF or Yes|No Default: ON**

ON -Enables Prioritized Acknowledgments

OFF -Acknowledgments have the same priority as other frames.

When ACKPRIOR is ON and the TNC receives a frame that it must acknowledge (ACK), it will immediately send the ACK if the channel is clear. Other stations with ACKPRIOR ON will defer accessing the channel for sufficient time to send the ACK, even if they cannot hear the station.

When ACKPRIOR is OFF, acknowledgments are queued up for transmission the same as any other frame.

**ACKTIME n Default: 14**

n = 0-250 in 10mSec increments

ACKTIME specifies the time required to send an RR or RNR response frame (an acknowledgement) to an I frame at the radio port data rate. This corresponds to about 510mSec at 1200 bps with 8 digipeaters and about 140 mSec at 1200 bps with no digipeaters. The default of 140 mSec (ACKT 14) allows for no digipeaters.

**ADRDISP ON|OFF or Yes|No Default: ON**

ON - Address headers on monitored frames will be displayed.

OFF - Address headers on monitored frames will not be displayed.

ADRDISP enables or disables the display of the callsign addresses in each monitored frame. The command applies only to the terminal display, not printer output. Examples with ADRDISP ON and OFF are shown below.

**N4UQQ>>N4UQR, TPA5\* <UI R>:This is a monitored frame.**

**This is a monitored frame.**

**AMONTH**      **ON|OFF or Yes|No**      **Default: ON**

- ON      - The month in all system dates will be alphabetic.
- OFF     - The month in all system dates will be numeric.

This command selects alphabetic (Jan., Feb.,) or numeric (01,02) format for the month in date displays. AMONTH does not affect the PMS date format.

|                                       |                   |
|---------------------------------------|-------------------|
| If AMONTH is ON:                      | If AMONTH is OFF: |
| Apr.-15-00 19:48:01      (DAYUSA ON)  | 04/15/00 19:48:01 |
| 15-Apr.-00 19:48:01      (DAYUSA OFF) | 15/04/00 19:48:01 |

**AUTOFWD**      **ON|OFF or Yes|No**      **Default: ON**

- ON      - PMS messages are automatically marked for forwarding.
- OFF     - PMS messages are not marked for forwarding.

This command enables automatic *marking* for forwarding of all messages with a callsign in the @ BBS field. This command does not cause forwarding to take place. To initiate forwarding, use the FPMS or FNPMS command or let the HOMEBBS to reverse forward.

**AUTOLF**      **ON|OFF or Yes|No**      **Default: ON**

- ON      - A <LF> is sent to the terminal after each <CR>.
- OFF     - A <LF> is not sent to the terminal after each <CR>.

AUTOLF controls the appending of Line Feed characters to Carriage Return (CR) characters received in packets and the echo of those that are typed in.

This command only affects what is sent to the terminal, not the data sent in packets. To add linefeed characters to outgoing packets, use LFADD.

**AWLEN**      **n**      **Default: 8**

n = 7-8, the number of data bits per word

To transmit and receive packets retaining all 8 data bits of each character, as you need to do if you send executable files or other special data, you should use Transparent Mode and set AWLEN 8. You can use Converse Mode and set AWLEN 8 and 8BITCONV ON, however the data you then send must handle the Converse Mode special characters with the PASS prefix.

**AX25L2V2**      **ON|OFF or Yes|No**      **Default: ON**

- ON      - The packet controller uses AX.25 Level 2 Version 2.0
- OFF     - The packet controller uses AX.25 Level 2 Version 1.0

Some implementations of the earlier version of AX.25 protocol won't properly digipeat version 2.0 AX.25 packets. This command provides compatibility with these other packet controllers. Version 1 of AX.25 (AX25L2V2 OFF) contains less overhead than Version 2 and is sometimes used in bandwidth limited situations. See also CHECK and CHECKV1.

**AXDELAY**     **n**                                     **Default: 0**

**n = 0 - 180, voice repeater keyup delay in 10 ms increments.**

AXDELAY specifies the period of time the packet controller is to wait, in addition to the normal TXDELAY, after keying the transmitter and before data is sent. This feature will be used when a standard "voice" repeater is used to extend range. This command works in conjunction with AXHANG.

**AXHANG**     **n**                                     **Default: 0**

**n = 0 - 20, voice repeater hang time in 100 ms increments**

This parameter can be used to increase the channel efficiency when voice repeaters with a hang time greater than 100 ms are used. For a repeater with a long hang time, it is not necessary to wait for the repeater keyup delay after keying the transmitter if the repeater is still transmitting. If the packet controller has heard a packet send within the hang period, it will not add the repeater keyup delay (AXDELAY) to the keyup time.

**BAUD**

**NOTE:** This command does not apply to all models. Some PacComm products use DIP switches or push-on jumpers for baud rate selection.

BAUD is an immediate command that displays the current terminal and radio baud rates and presents a selection menu. The initial portion of the BAUD display lists the current data rate of the terminal port and the radio port in use. The second portion of the display lists all supported radio and terminal baud rates and a command letter from each. A typical BAUD display:

|                 |                   |                 |               |
|-----------------|-------------------|-----------------|---------------|
| <b>Radio:</b>   | <b>1200</b>       |                 |               |
| <b>Port 1:</b>  | <b>9600</b>       |                 |               |
| <b>Port 2:</b>  | <b>4800</b>       |                 |               |
|                 | <b>Baud Rates</b> |                 |               |
| <b>Radio</b>    | <b>Port 1</b>     |                 | <b>Port 2</b> |
| <b>A - 1200</b> | <b>L - 300</b>    | <b>R - 300</b>  |               |
| <b>B - 1200</b> | <b>M - 1200</b>   | <b>S - 1200</b> |               |
| <b>C - 1200</b> | <b>N - 2400</b>   | <b>T - 2400</b> |               |
| <b>D - 1200</b> | <b>O - 4800</b>   | <b>U - 4800</b> |               |
|                 | <b>P - 9600</b>   | <b>V - 9600</b> |               |

- X - Make changes after restart**
- Z - Make changes immediately ( Z= ZAP )**

**Select?**

Enter the letter X <CR> to return to the command prompt without making any changes to the existing data rates, or enter the letter which corresponds to the desired baud rate. The menu will reappear to allow correction or additional selections. When ready to accept the changes, enter X<CR> followed by the RESTART command or a power-off/power-on cycle of the TNC. This allows

time for changing the terminal baud rate before the packet controller changes. For baud rate changes to take place immediately, press the letter Z.

The BAUD command may be used at any time without changing the link state. The radio baud rate should NOT be changed if a connection exists. Only radio baud rates supported by the modem hardware should be selected. (some models only display the choices which the hardware supports.)

The data rates assigned to each letter may vary between products. Use the letters presented by the packet controller, not the table above.

**BBSMSGS**      ON|OFF or Yes|No      **Default: ON**

This command controls how the packet controller displays certain messages in Command and Converse Modes.

| <u>MESSAGE</u>              | <u>EFFECT OF MMSMSGS =ON</u>  |
|-----------------------------|-------------------------------|
| *** CONNECTED TO XXXXX      | Message appears on a new line |
| *** DISCONNECTED            | Message appears on a new line |
| *** retry limit exceeded    | Message appears on a new line |
| *** XXXXXX Busy             | Message appears on a new line |
| *** FRMR sent               | Message appears on a new line |
| *** FRMR received           | Message appears on a new line |
| *** Connect request: XXXXXX | This message is omitted       |

The BBSMSGS command is useful for host operation with bulletin board software that requires link state messages to begin in the first display column.

**BEACON**      Every|After n      **Default: ON**

EVERY - Beacon at regular intervals.  
 AFTER - Beacon after specified interval with no activity.  
       n = 1 - 250, beacon timing in 10 second intervals (if BRANGE = 1)  
       n = 0 disables beacons.

This command enables sending beacon and causes the first beacon frame to be transmitted. A beacon frame consists of the text of BTEXT in a packet addressed to the callsign in the TO field via the digipeat addresses specified by the UNPROTO command.

See also the BRANGE command which sets the beacon interval range.

**BSLOT**      n      **Default: 60**

n = 0 - 59 - selects the second to be used for transmission of BTEXT when using the Beacon Slotting function. A value of 60 disables the function.

This command is used in conjunction with BESLOT and BSUBSLOT to enable TDMA transmissions using BTEXT data. It allows an intelligent device to load data into the TNC for transmission in a precise time slot.

This command assigns this controller a one second slot each minute for time-slotted beaconing when BESLOT is ON.

See BSUBSLOT for assigning multiple slots per second.

**BESLOT**      **ON|OFF or Yes|No**      **Default: ON**

- ON      - Selects TDMA beacon timing
- OFF     - Selects conventional beacon timing.

This command is used in conjunction with BSLOT and BSUBSLOT to enable time-slotted transmissions using BTEXT data. It allows an intelligent device to load a data string into the TNC for transmission in a precise time slot.

**BKONDEL**    **ON|OFF or Yes|No**      **Default: ON**

- ON      - <BACKSPACE><SPACE><BACKSPACE> is echoed when a character is deleted.
- OFF     - The <MS>BACKSLASH>() is echoed when a character is deleted.

This command determines the way the display is updated to reflect a character deletion in Command or Converse Mode.

The <BACKSPACE><SPACE><BACKSPACE>sequence will properly update a video display. For a paper-output display, or if the terminal does not respond to the <BACKSPACE>character (<CTRL-H>), set BKONDEL OFF.

**BRANGE**      **n**      **Default: 3**

- n = 1    Not supported.
- 2        1 second
- 3        10 seconds (default and traditional value)
- 4        100 seconds

This command sets the beacon timing multiplier by which the beacon timer increments. The BRANGE command allows beacons to be sent from once per second to once per about each 7 hours.

With BRANGE = 1 (default value), the command B E 1 (beacon every one) will transmit a beacon each ten seconds (1 x an increment of 10).

If BRANGE is set to 4, the B E 1 will trigger a beacon every 100 seconds (1 x an increment of 100). (see LRANGE for Location beacon timing increments).

**BREAKON|OFF or Yes|No**      **Default: ON**

- ON      - The BREAK signal operates as described in the manual.
- OFF     - The packet controller ignores the BREAK signal.

The BREAK command controls enabling or disabling packet controller response to the BREAK signal. The BREAK signal is a 'space' condition on the

serial data input line for longer than two character times, which can be generated by many computers and terminals. Some devices will generate an inadvertent BREAK signal during initialization, which may force the packet controller into Command Mode. Setting BREAK to OFF eliminates this.

**BSUBSLOT**      **n**      **Default: 0**

n = 0-9 assigns the number of 100 mS subslots used with beacon slotting.

This command is used in conjunction with BESLOT and BSLOT to enable TDMA transmissions using BTEXT data. It allows an intelligent device to load a data string into the TNC for transmission in a precise time slot.

BSUBSLOT assigns the time offset in the assigned BSLOT second at which transmission begins. This allows multiple modems to be assigned the same BSLOT but transmit at staggered times to avoid collisions. A value of 0 causes the beacon to be sent at the beginning of the BSLOT second; a value of 5 causes the beacon to be sent 500 mS after the beginning of the BSLOT second.

If beacon transmissions do not exceed 100 mS in length, for example, ten packet modems may be assigned the same BSLOT if each one uses a different BSUBSLOT, thus allowing ten timed beacons per second. If beacon transmissions are longer than 100 mS, between 100 and 200 mS, for example, five beacons per second may be accommodated by assigning BSUBSLOT values of 0,2,4,6, and 8. In the same fashion, three subslots of 300 mS each (and one of 400 mS) will be achieved using BSUBSLOT values of 0,3, and 6.

**BTEXT**      **text**      **Default: blank**

BTEXT specifies the content of the data portion of a beacon packet. The default text is blank, i.e., no message. Multiple-line messages may be put into the beacon by including carriage return <CR> characters as needed in the text preceded by the PASS character.

If a text string longer than 120 characters is entered, an error message will appear and the command will be ignored.

To clear the BTEXT text without using the RESET command, enter a new BTEXT with a % or & as the first character in the text.

NOTE: No beacons will be sent if BTEXT is blank.

**BUDLIST**      **ON|OFF or Yes|No**      **Default: OFF**

ON      - Ignore frames from stations that are not in the LCALLS list.  
OFF     - Ignore frames from stations that are listed in LCALLS.

BUDLIST specifies whether the callsigns in the LCALLS list are ignored (and thus not monitored, repeated, or allowed to connect) or, alternatively, are the only ones which are monitored, repeated, or allowed to connect.



BUDLIST works in conjunction with the command LCALLS, which sets up a callsign list. These commands determine which packets will be displayed when MONITOR is ON.

BUDLIST and LCALLS also affect whether the listed callsigns may connect or digipeat. (This aspect of these commands varies by model.)

### **BYE**

A command used by a PMS over-the-air user.

This command requests the PMS to disconnect the user by issuing a disconnect command. The user will see the following messages:

**-Logged off**  
**\*\*\*DISCONNECTED**

There will be up to a 10 second delay after the “-Logged off” message is received before the PMS issues the disconnect request.

If a connection exists to the PMS and there is no radio port activity for approximately five minutes, the PMS will issue a disconnect command.

### **CALIBRA**

This command does not apply to all models. Refer to the Technical Reference manual for details about calibration procedures and the operation of this command.

CALIBRA is an immediate command used to transfer control to the modem tone generation routine. The CALIBRA command may be performed at any time without altering the current link state. The command is useful for generating tones for adjusting radio transmit levels, etc, even on controller models which do not require its use for calibration.

The subcommands available in the calibration routine are:

|         |  |
|---------|--|
| <SPACE> | Switch the transmit audio to the other tone. |
| K       | Toggle PTT line on/off.                      |
| D       | Alternately pulse both tones.                |
| Q       | Quit calibration routine.                    |

### **CALSET            n                            Default: NONE**

**n = 0 - 65535 setting the count setting for the calibration routine.**

This command does not apply to all models. The CALSET command is provided for continued support of the TNC-200 product. The functions of CALSET are not useful with any other PacComm TNC.

The number to be specified by CALSET is determined by the frequency to be calibrated as follows:

modulator tones:  $n = (525,000 / f) + 1$

demodulator tones:  $n = (262,000 / f) + 1$

Round n to the nearest integer.

**CANLINE**      **n**      **Default: \$18{CNTL-X}**

n = 0 - \$7F, specifying an ASCII character code.

This command sets the cancel-line input editing command character. The parameter n is the ASCII code for the character you want to type in order to cancel an input line. Enter the code in either hex or decimal. For example, to change the cancel-line character to <CNTL-U>, set CAN \$15 or CAN 21.

If you cancel an input line in Command Mode, the line will be terminated with a <BACKSLASH> ( \ ) and a new cmd: prompt. If you cancel a line in Converse Mode, you will see only the < BACKSLASH> and a new line.

You may cancel only the line currently being typed. Once a <CR> has been entered, you cannot cancel an input line using the cancel-line character. If the send-packet character is not <CR>, the cancel-line character will cancel only the last line of a multi-line packet. To cancel the entire packet, use the CANPAC character.

Line cancellation is disabled in Transparent Mode.

**CANPAC**      **n**      **Default: \$19{CNTL-Y}**

n = 0 - \$7F, specifying an ASCII character code.

CANPAC is used to set the cancel-packet input editing command character. The parameter n is the ASCII code for the character you want to type in order to cancel an input packet. You can enter the code in either hex or decimal.

If you cancel a packet in Converse Mode, the line will be terminated with a <BACKSLASH> ( \ ) and a new line. You can only cancel the packet that is currently being entered. Once you have typed the send-packet character, or waited PACTIME [if CPACTIME enabled], the packet can not be canceled.

Packet cancellation is disabled in Transparent Mode.

The cancel-packet character also cancels display output in Command Mode. If the cancel-packet character is typed while in Command Mode, any characters that would be sent to the screen (except echoed characters) are "thrown away." Typing the cancel-output character a second time restores output. To see this work, type DISPLAY, then a <CTRL-Y>. The command list display will stop. You won't see any response from the packet controller to commands. Now type another <CTRL-Y>, and DISPLAY to see the normal display again.

**CBELL**            **ON|OFF or Yes|No**            **Default: OFF**

- ON     - A bell character is sent with the connect message.
- OFF   - No bell character is included in the connect message.

The CBELL command controls whether an ASCII \$07 (BELL) character is sent as part of the connected message. When CBELL is ON, the bell character immediately precedes the asterisk portion of the connected indication.

CBELL produces a 'CONNECT BELL' even if MFILTER is set to delete \$07 (BELL) characters. MFILTER only operates on the message body.

**CHECK**                    **n**                    **Default: 30**

- n = 1 -250, specifying the check time in 10 second intervals.
- A value of 0 disables this feature.

CHECK sets the connection timeout. When the packet controller is connected to another station, it will try to close the link if the specified CHECK time elapses without any packets being heard from the other controller.

If AX25L2V2 is ON, the packet controller will send a "check packet" if no packets have been heard from the connected station for n\*10 seconds.. If a response is not heard after RETRY+1 check attempts, it commences a disconnect sequence, as if the DISCONNECT command had been given.

If AX25L2V2 is OFF, use the CHECKV1 command.

**CHECKV1**            **ON|OFF or Yes|No**            **Default: OFF**

- ON     - Enables CHECK time when running AX.25 Version 1.
- OFF   - Requires a manual disconnect sequence.

When ON, the CHECK (T3) timer is used to automatically disconnect an AX.25 Level 2 Version 1.0 link when data hasn't flowed for CHECK time. This will result in an automatic disconnect when packets haven't flowed between this TNC and the REMOTE TNC for CHECK time.

When OFF, V. 1.0 procedures require a manual disconnect of an inactive link.

**CLKADJ**                    **n**                    **Default: 0**

- n = 0 - 65535, specifying the real-time clock speedup factor.

This command allows the clock speed to be increased to compensate for the tendency to lose time when the radio port is very active. If the value of CLKADJ is non-zero, then the correction factor is calculated as:

$$\text{relative clock speed in \%} = 100 + (9.16667 * 1/n).$$

NOTE: A small value of n has a large effect on the clock speed, a large value of n has a small effect. A value of "0" means no correction will be applied.

**CLKSET      ON|OFF or Yes|No      Default: ON**

- |     |   |
|-----|---|
| ON  | - The controller will accept clock update from HOMEBBS. |
| OFF | - The controller ignores clock updates.                 |

If CLKSET is ON and the HOMEBBS supports clock updating, the TNC date and time will be updated when the HOME BBS connects to the PMS.

**CMDTIME      n      Default: 1**

|   |
|---|
| n = 0 - 250, Transparent Mode timeout value in seconds. |
|---|

This command sets the Transparent Mode timeout value.

Three Command Mode entry characters must be entered less than CMDTIME seconds apart, with no intervening characters, after a delay of CMDTIME seconds since the last characters were typed. After a final delay of CMDTIME seconds, the controller will enter Command Mode (cmd: prompt).

For example, using default values, a period of one second must elapse with no input, followed by three <CTRL-C> within one second, followed by an additional one second with no input.

If n is zero, the only exit from Transparent Mode is sending the BREAK signal.

**CMSG      ON|OFF or Yes|No      Default: OFF**

- |     |  |
|-----|--|
| ON  | - A text message is sent when a connection is established. |
| OFF | - The text message is not sent.                            |

CMSG ON enables automatic sending of the message contained in CTEXT whenever the packet controller accepts a connect request. No CMSG will be sent if CTEXT is blank, even if CMSG is ON.

CMSG is useful for an automatic human-readable greeting, and also for sending an initiation or connection acknowledgement string to the device attached to the controller initiating the connection.

See also CONRPT which sends a location report similar to CMSG.

**CMSG2      ON|OFF or Yes|No      Default: OFF**

- |     |   |
|-----|---|
| ON  | - A text message is sent by calling TNC after connecting. |
| OFF | - The text message is not sent.                           |

CMSG2 ON enables automatic sending of the message contained in CTEXT whenever a connection is established which was initiated by the packet controller. No CMSG will be sent if CTEXT is blank, even if CMSG is ON.

CMSG2 is useful for an automatic human-readable greeting, and also for sending an initiation or connection acknowledgement string to the device attached to the controller **accepting** the connection.

See also CONRPT which sends a location report similar to CMSG.

**CMSGDISC**    **ON|OFF or Yes|No**                    **Default: OFF**

|     |  |
|-----|--|
| ON  | - The packet controller will disconnect immediately after receiving acknowledgement of the CTEXT sent by the CMSG command. |
| OFF | - The controller will not disconnect after sending CMSG.   |

CMSGDISC controls whether the controller will automatically disconnect after the CMSG packet containing the connect text (CTEXT) is acknowledged.

**COMMAND**    **n**    **Default: \$03{CNTL-C}**

|   |
|---|
| n = 0 - \$7F, specifying an ASCII character code. |
|---|

This command sets the Command Mode entry character. The code may be entered in either hexadecimal or decimal. Command Mode is entered from Converse Mode when this character is typed. If it is input while already in Command Mode, nothing happens.

See CMDTIME for information on how the Command Mode entry character is used to escape from Transparent Mode.

**CONMODE**    **Converse|Transparent**                    **Default: Conv**

|             |  |
|-------------|--|
| Converse    | - Sets entry to Converse Mode when connection begins.    |
| Transparent | - Sets entry to Transparent Mode when connection begins. |

CONMODE selects which data transfer mode the packet controller will enter when a connection is established or when power is applied if UIMODE (DATAMODE) is ON. The connection may result either from a radio connect request or a keyboard command. If the connection is made from the keyboard, the timing of the mode change is determined by NEWMODE.

If the packet controller is already in Converse or Transparent Mode when the connection is completed, the mode will not be changed.

If part of a command line has been entered when the connection is completed, the mode change will not take place until the command is completed or the line is canceled to prevent the last part of the command from being sent as data.

**CONNECT**    **call#1 [ Via call#2[call#3..., call#9]]**

|        |  |
|--------|--|
| call#1 | - Callsign of packet controller to be connected to.  |
| call#2 | - Optional callsign of station to act as digipeater. |

CONNECT initiates a connect request to call#1, optionally through one or more digipeaters [VIA call#2[,call#3...,call#9]]. An error message is returned if

the controller is already in a connected state, or is attempting to connect or disconnect. If no response to the connect request occurs after RETRY attempts, the command is aborted and a failure message is displayed.

The double-bracketed text, “[call#3...,call#9],” is only used if Via call#2 is present. The brackets are not typed. Each callsign may include an optional sub-station ID (specified as “-n”). The digipeater callsign fields are entered in the order in which you want them to relay the packets to the destination, call#1, separated by spaces or commas.

If NEWMODE is ON, the controller will immediately enter the data transfer mode specified by CONMODE . If NEWMODE is OFF, the controller will enter the data transfer mode when the connection is completed.

**CONOK                      ON/OFF or Yes/No                      Default: OFF**

|     |                                      |
|-----|--------------------------------------|
| ON  | - Connect requests will be accepted. |
| OFF | - Connect requests will be rejected. |

This command determines the action taken by the controller when it receives a connect request. If CONOK is ON, the connection will be completed.

If CONOK is OFF the packet controller will issue a DM packet, or “busy signal” to the requesting station and display (except in Transparent Mode):

**connect request: XXXXXX(callsign of station attempting to connect)**

When a DM packet is received in response to a connect request, the packet controller will display:

**\*\*\* XXXXXX station busy (callsign to which connect was attempted)**

**CONPERM                      ON/OFF or Yes/No                      Default: OFF**

|     |   |
|-----|---|
| ON  | - The current stream's connection will be maintained.   |
| OFF | - The current stream connects and disconnects normally. |

CONPERM ON forces the packet controller to always maintain the current connection, even when RETRY attempts exceed the limit. RESTART and power cycling do not affect this connected state. If the connection is broken, connect requests will be sent indefinitely until the connection is re-established.

A connection must already exist for CONPERM to take effect. It functions on a stream-by-stream basis when multiple connections are enabled.

**CONRPT                      ON/OFF or Yes/No                      Default: OFF**

|     |   |
|-----|---|
| ON  | - The GPS buffers' contents are sent when a connection is accepted. |
| OFF | - Capture buffers are not sent when a station connects to the TNC.  |

If CONRPT is enabled, the GPS capture buffers; LTEXT, L1TEXT, L2TEXT, and L3TEXT; STEXT (if it contains data); and CTEXT (if it contains data and CMSG is set to ON) will be transmitted whenever a connection is made.

CMSGDISC controls whether the connection is maintained or broken.

**CONSTAMP** ON|OFF or Yes|No **Default: OFF**

|     |   |
|-----|---|
| ON  | - Connect status messages are time stamped.     |
| OFF | - Connect status messages are not time stamped. |

CONSTAMP enables time stamping of \*\*\* CONNECTED status messages.

DAYTIME must be set for time stamping to occur. The date format is set by the DAYUSA command. If CONSTAMP and DAYUSA are ON, and the date and time have been set, a connect message might appear as follows:

\*\*\* CONNECTED to KL7EV [05/28/97 16:28:31]

**CONVERSE** or **K**

K is a single letter alias for Converse.

CONVERSE is an immediate command which causes the packet controller to change from the Command Mode into the Converse Mode. The link connection is not affected. Once in the Converse Mode, everything entering the serial port is packetized and transmitted. Entering the Command Mode entry character returns the packet controller to the Command Mode.

**CPACTIME** ON|OFF or Yes|No **Default: OFF**

|     |  |
|-----|--|
| ON  | - Packet timeout is used in Converse Mode.     |
| OFF | - Packet timeout is not used in Converse Mode. |

This command enables the periodic automatic sending of packets in Converse Mode. After CPACTIME has elapsed since the last frame was transmitted, any characters which have been input to the terminal will be transmitted.

If CPACTIME is ON, characters are packetized and transmitted periodically as they are in Transparent Mode, but local editing and display features of Converse Mode are enabled, and software control may be used. The SENDPAC character appearing in the text will also trigger transmission of a packet.

**CPOLL** n **Default: blank**

|  |
|--|
| n = 1 to 4 ASCII characters specifying the CPOLL match string. |
|--|

Enter from 1 to 4 characters, followed by a <CR> into the CPOLL buffer. This is the match string to cause the remote TNC to send back it's LTEXT and L1TEXT buffers. Please note it only sends back those two buffers.

The string must be sent by the polling TNC as the first characters of an I frame sent to the polled TNC. The polled TNC will then respond with it's buffers, if they have anything in them.

You cannot use any of the special characters that do other things to the TNC, like the | which is the stream switch character, and of course you can not use the special characters that clear the text buffers.

**CR      ON|OFF or Yes|No                      Default: ON**

|     |   |
|-----|---|
| ON  | - The send-packet character, normally <CR>, is appended to all packets sent in Converse Mode. |
| OFF | - The send-packet character is not appended to packets.                                       |

When CR is ON, all packets sent in Converse Mode include the send-packet character which forces the packet to be sent. If CR is OFF, the send-packet character is interpreted only as a command, and is not included in the packet

CR ON and SENDPAC \$0D gives a natural conversation mode. Each line is sent when <CR> is entered, and arrives with <CR> at the end of the line. If the station at the other end reports overprinting of lines on his display, set LFADD ON, or the other station can set AUTOLF ON.

**CRAFTER      ON|OFF or Yes|No                      Default: ON**

|     |  |
|-----|--|
| ON  | - A carriage return <<CR>> is sent to the terminal after each frame. |
| OFF | - Monitored frames are displayed without adding a <<CR>>.            |

CRAFTER OFF eliminates the <CR>character which is normally added to the end of each monitored frame. CRAFTER affects data on both the terminal and printer ports.

If monitored frames overwrite themselves on the same line, set CRAFTER ON. If monitored frames are double-spaced, set CRAFTER OFF.

**CSTATUS**

CSTATUS is an immediate command which shows the stream identifier and link state of all streams (links), the current input and output streams, and whether or not each stream is "permanent" (see CONPERM). For example:

```
cmd:CS
A stream -            I/O Link state is:    CONNECTED to N0ADI via K9NG
B stream -            Link state is:        CONNECTED to AD7I-2 P
C stream -            Link state is:        CONNECTED to G6DLJ
D stream -            Link state is:        CONNECTED to K4ABT
E stream -            Link state is:        DISCONNECTED
```

The example shows A stream is the currently active stream for both input and output, indicated by the I and O symbols. The B stream is connected to AD7I "permanently." All other streams' states are shown as they might normally appear with multiple connections.





packet connection exists, since the data stream might be interpreted as commands by the packet modem..

Once DATALOG is set to ON; it can only be set to OFF by an over-the-air remote command or by removing the memory backup battery jumper to return all parameters to factory settings.

**DATAMODE            ON|OFF or Yes|No            Default: OFF**

ON - The controller initializes in CONMODE.

OFF - The controller initializes in Command mode.

When DATAMODE is OFF, the packet controller initializes to the Command Mode and waits for a command from the asynchronous serial port.

When DATAMODE is ON, the packet controller initializes into the CONMODE without any commands from the serial port. Any characters received from the serial port will be packetized and transmitted as UI frames.

On some models/some firmware versions this command is named UIMODE.

**DAYTIME            yyyymmddhhmm            Default: none**

yyymmddhhmm - Current date and time to set.

This command sets the current date and time for the packet controller. If the command DAYTIME is entered without a parameter, the controller will display the current date and time setting.

yyyy are the four digits of the year, mm is the two-digit month code (01-12), dd is the day (1-31), hh is the hour (00-23), and mm is the minutes after the hour (00-59). All these codes except the year must be exactly two digits; numbers from 0 to 9 must be entered with leading zeros.

This command automatically supports the hardware clock if installed.

Related commands: UTC, FIXTYP.

**DAYUSA            ON|OFF or Yes|No            Default: ON**

ON - Date displayed in the US form as mm/dd/yy

OFF - Date displayed in the European form as dd-mm-yy.

This command affects the format of the date display used in "time stamps" as well as when the command DAYTIME is entered without parameters. The format for entering time using DAYTIME is not affected.

**DEADTIME            Discontinued Command**

The DEADTIME command is no longer supported in PacComm firmware. The command may be present in some firmware versions, but is not operative.

**DELETE            ON|Off or Yes|No            Default: OFF**

- ON        - The DELETE character editing key is <DELETE> (\$7F)
- OFF      - The DELETE character editing key is <BACKSPACE> (\$08)

This command sets the editing command for character deletion. When this character is typed, the last character from the input line is deleted. How the controller indicates the deletion is controlled by the BKONDEL command.

DELETE will not delete past the beginning of a line, however <CR> characters that have been entered in the text with the pass character may be deleted.

To see a corrected display of the current line after you have deleted characters, type the redisplay-line character, which is set by the REDISPLA command.

**DGPSCALL            call[-n]            Default: RTCM**

- call      - To-callsign of the frame to be treated as DGPS data.
- n        - 0-15, an optionally specified sub-station ID (SSID).

DGPSCALL sets the to-callsign which the TNC uses to identify DGPS frames.

**DIGIPEAT            n            Default: 7**

- 0        - DIGIPEAT OFF
- 1        - DIGIPEAT ON and DIGI-SWAP enabled
- 2        - DIGIPEAT ON and DIGI-NOT-OWN enabled
- 3        - DIGIPEAT ON, DIGI-NOT-OWN and DIGI-SWAP enabled
- 4        - DIGIPEAT ON and DIGI-ONCE enabled
- 5        - DIGIPEAT ON, DIGI-SWAP and DIGI-ONCE enabled
- 6        - DIGIPEAT ON, DIGI-NOT-OWN and DIGI-ONCE enabled
- 7        - DIGIPEAT ON, DIGI-SWAP, DIGI-NOT-OWN, and DIGI-ONCE enabled (**default**)
- 8        - DIGIPEAT ON ( the former DIGIPEAT ON without new features)

When DIGIPEAT is ON, i.e. n = any non-zero value, every packet received with the packet controller's callsign (and SSID) or MYALIAS callsign in the digipeat list of its address field will be retransmitted, subject to the restrictions of DIGI-NOT-OWN and DIGI-ONCE (below). Each station included in the digipeat list relays the packet in its turn.

Digipeating takes place concurrently with other operations and does not interfere with normal packet operation. If the packet transmitter is observed keying up without apparent reason, it is likely that it was digipeating a frame.

The HID command enables automatic ID for dedicated digipeaters.

**DIGI-SWAP** - This function causes the TNC to replace the alias (generic) callsign in a frame with MYCALL when the TNC digipeats the frame. This

allows subsequent stations to know the real path taken by the frame so that a reverse addressed frame may be sent back. It also places valid packet station identification in the frame.

**DIGI-NOT-OWN** - This function causes the TNC to never digipeat a frame that was originated with its own MYCALL. It prevents multiple repeating of the same frame due to multiple alias callsigns when DIGI-SWAP is off.

**DIGI-ONCE** - With DIGI-ONCE ON, it will not repeat the frame a second time regardless of which alias callsigns may match.

#### **DISCONNECT**

**DISCONNECT** is an immediate command which initiates a disconnect from the currently connected station. A successful disconnect results in the display:

**\*\*\* DISCONNECTED**

Other commands may be entered while the disconnect is taking place, although connects are disallowed on that stream until the disconnect is completed. If the retry count is exceeded while waiting for the other side to acknowledge, the packet controller moves to the disconnected state. If a second **DISCONNECT** command is entered while the packet controller is disconnecting, the retry count is immediately set to the maximum number resulting in an immediate disconnected state.

In either case, the disconnect message is:

**\*\*\* retry count exceeded**

**\*\*\* DISCONNECTED**

Disconnect messages are not displayed when the packet controller is in Transparent Mode.

#### **DISPLAY [ class = A, B, C, H, I, L, M, P, T]**

Class is an optional parameter, class identifier, one of the following:

|                              |  |
|------------------------------|--|
| <b>Async</b>                 | display asynchronous port parameters   |
| <b>Bbs</b>                   | display PMS parameters                 |
| <b>Character</b>             | display special characters             |
| <b>GPS</b>                   | display GPS parameters                 |
| <b>Health &amp; Hardware</b> | display health counters and LED status |
| <b>Id</b>                    | display ID characters                  |
| <b>Link</b>                  | display link parameters                |
| <b>Monitor</b>               | display monitor parameters             |
| <b>Printer</b>               | display monitor parameters             |
| <b>Timing</b>                | display timing parameters              |



The EDITHDR command edits PMS message headers to allow re-addressing of messages (changing the TO: callsign) and revising the callsign in the '@ BBS' field. It does not allow editing the BID.

The EDITHDR command needs the message number and either or both callsigns. If parameters are incorrect, the following will be displayed:

**Parameters are missing**

To revise only the 'TO:' callsign of message 9, enter the following:

*cmd: EDITHDR 9 W4MUA <CR>*

The PMS will respond with the following display:

| Msg # | Stat | Date     | Time  | To   | From | @ BBS            |
|-------|------|----------|-------|------|------|------------------|
| 9     | T    | 07/15/94 | 09:54 | WIAW | WS4Z | @ W4DPH VE tests |

New message header

| Msg # | Stat | Date     | Time  | To    | From | @ BBS            |
|-------|------|----------|-------|-------|------|------------------|
| 9     | T    | 07/15/94 | 09:54 | W4MUA | WS4Z | @ W4DPH VE tests |

Similarly, to revise only the '@ BBS:' callsign of message 9, enter:

*cmd: EDITHDR 9 @K0ZXF <CR>*

To revise both callsigns in message 9, enter the following:

*cmd: EDITHDR 9 N4UQR K0ZXF <CR>*

To remove the callsign in the '@ BBS' field in message 9 and leave the field blank, enter the following:

*cmd: EDITHDR 9 @<CR>*

Note: The 'before' and 'after' displays have been omitted.

**ELOC**                      **n**    **Default: 0**

- 0 = off
- 1 = sends content of location beacons to terminal port only
- 2 = sends content of location beacons to terminal and RF port

ELOC enables or disables echoing the contents of the LOcation beacons to the serial port. This allows monitoring of one's own location beacons.

ELOC allows monitoring one's own transmitted location beacons by echoing the data sent over the radio port to the terminal serial port. This monitoring is useful with mapping programs to allow reception of one's own location report in the same format as those received over the air.

**◆ ENCRYPT    ON|OFF or Yes|No                    Default: OFF**

ON        - Encrypts data by XORing text in KEY parameter.  
OFF        - Sends data 'in the clear'

This command causes the text for the information portion of the packet to be XORed with the text that is given in the KEY parameter. The bits will also be shifted by the number in the ENSHIFT parameter. Both sender and receiver need to have the same KEY and ENSHIFT values for information to be decoded properly.

**◆ ENSHIFT    n    Default: 2**

n = 0-7, encryption bit shift value.

This parameter defines the number of bits to shift before the exclusive OR (XOR) process used for encryption. Both sender and receiver need to have the same KEY and ENSHIFT values for information to be decoded properly.

The typical use of this parameter is to allow short term changes in the encryption pattern by changing this single digit and leaving the 80 character key untouched. For example, the same KEY may be used by eight different operators by setting ENSHIFT.

**ESCAPE        ON|OFF or Yes|No                    Default: OFF**

ON        - The <ESCAPE> character (\$1B) is output as "\$" (\$24).  
OFF        - The <ESCAPE> (\$1B) character is output as (\$1B).

This command specifies the character which will be output when an <ESCAPE> character is sent to the terminal. The <ESCAPE> translation is disabled in Transparent Mode.

Some terminals interpret the <ESCAPE> character as a special command prefix. If you have such a terminal, protect yourself for unexpected text sequences by setting ESCAPE ON. See also MFILTER.

**FIRMRNR        ON|OFF or Yes|No                    Default: ON**

ON        - FIRMRNR is active.  
OFF        - FIRMRNR is disabled.

This command is used to prevent the frequent polling of remote TNCs when they are busy. The command works around the AX.25 Version 2 protocol specification for busy-poll timing, effectively eliminating excessive control frames being sent to a packet controller which has indicated it can accept no more data at the current time.

This command operates properly with remote TNCs having FIRMRNR set to ON and with most network nodes.

**FIXTYPE        n    Default: 1**

**n = 0 - 5 (see detailed descriptions below)**

NOTE1: This command is not implemented on all models.

NOTE2: The labeling of the FIX LED may vary among products.

This command establishes how the packet controller determines if a good fix has been obtained by the GPS receiver for control of the packet controller's FIX LED. Some options also let the FIX LED be triggered by non-GPS data if desired.

0 = disable the function, i.e. do not check for a good fix and do not control the FIX/AUX LED.

1 = Use the \$GPGGA string to verify a good fix. (note that \$GPGGA has to be specified as one of the TNC GPS capture fields (GPSText, LG1text, LG2text, LG3text), but it can be any one of the four fields).

2 = If any string specified in any of the TNC GPS capture fields (GPSText, LG1text, LG2text, LG3text) has a length of greater than 34, this will identify a good fix. (Since most GPS receivers don't put out any sentences or put out shortened ones when there is no fix, this option may allow effective fix determination based on sentence length).

3 = If any string specified in any of the GPS capture fields (GPSText, LG1text, LG2text, LG3text) is exactly matched by a received string, this will identify a good fix. This is like option 2, but there is no minimum string length. For example if LG3text is set to \$GPGSV and the GPS puts out \$GPGSV;x,0 there will be a match.

4 = Use only LTEXT field to search for a string >34 characters for a good fix. This option uses only the data in LTEXT (as specified by GPSText search) and ignores the LG1/2/3TEXT fields. This lets the data collected in LG1/2/3TEXT to be from something such as a weather station without affecting the good fix LED.

5 = Use the \$GPRMC string to verify a good fix. (note that \$GPRMC has to be specified as one of the TNC GPS capture fields (GPSText, LG1text, LG2text, LG3text), but it can be any one of the four fields).

**FLOW            ON|OFF or Yes|No            Default: ON**

ON        - Type-in flow control is active.

OFF       - Type-in flow control is disabled.

Setting FLOW ON will keep received data from interfering with data entry.

When FLOW is ON, any character entered from the terminal will halt output



to the terminal until: 1) a packet is forced (in Converse Mode); 2) a line is completed (in Command Mode); 3) the packet length is exceeded; or, 4) the terminal output buffer fills up. Canceling the current command, packet, or typing the re-display character will also cause the output to resume. Type-in flow control is not used in Transparent Mode.

## FORWARD

*n* = the number of the message to be marked for forwarding

This command allows messages to be marked for forwarding to another BBS station. Automatic forwarding is not supported to reduce channel congestion.

The PacComm PMS (Personal Message System) supports message forwarding (see FPMS, FNPMS, RFPMS, and RFNPMS commands) and automatic reverse forwarding. If you have an arrangement with your local BBS Sysop to forward BBS mail to your PMS, then the PMS will forward *marked* messages to the local BBS when the BBS connects to deliver your mail.

If you type:

**cmd: FORWARD *n* <CR>**

The PMS will respond with:

**Message marked for forwarding**

If you try to mark a bulletin for forwarding, the PMS will display:

**You cannot forward a bulletin**

The FORWARD command also is used to remove the forwarding flag from a marked message. To undo the forwarding of a message, enter:

**cmd: FORWARD *n* <CR>**

The PMS will respond with the message:

**Message forwarding reset**

## FNPMS *call#1* [Via *call #2*]

*call #1* - Callsign of node or switch to be connected to.

*call #2* - Optional callsign of station to be digipeated through.

The purpose of this command is to forward marked messages to another PMS station via a network connection.

The FNPMS command causes the PMS to connect to a node or switch (*call #1*) via no more than one digipeater (*call #2*). Once this connection exists, the PMS sends the node the connect string contained in NODETEXT to cause the node to connect to the desired BBS/PMS station. When that connection is established, the PMS uploads all messages marked for forwarding.

If the station connected to by the NODETEXT is the HOME BBS, the standard BBS forwarding format will be used for transferring messages, otherwise the PMS will follow the standard "human" format.

If the FNPMS command is used to connect to a station which is not a node, the NODETEXT will be sent but will be interpreted as data and no further action will take place. After approximately five minutes, the PMS will time-out and disconnect.

If the station connected to by the NODETEXT command string is not a BBS, capable of receiving PMS messages, or if a forwarding error occurs, automatic disconnection takes place.

**FPMS**            **call #1 [Via call #2]**

call #1 - Callsign of BBS/PMS station to be connected to.  
call #2 - Optional callsign of station to be digipeated through.

This command causes the PMS to connect to a BBS/PMS station (call #1) via no more than one digipeater (call #2). The callsign string may not exceed 23 characters. Once this connection exists, the PMS uploads all messages marked for forwarding.

This command may be used to upload messages to another PMS or human operator as well as a conventional BBS. If the station connected to by the FPMS command is the HOME BBS, the standard BBS forwarding format will be used for transferring messages, otherwise the PMS will follow the "human" format.

If the FPMS command is used to connect to a station which is not a BBS or PMS capable of receiving PMS messages, or if a forwarding protocol error occurs, automatic disconnection occurs.

**FRACK**            **n**                            **Default: 3 [HF 6]**

n = 1 - 15, frame acknowledgement timeout in seconds.

After transmitting a packet requiring acknowledgement, the packet controller waits the frame acknowledgement timeout before incrementing the retry counter and sending the frame again.

If the packet address includes digipeaters, the Retry interval is adjusted to  $n * (2^m + 1)$  where m is the number of relay stations.

**FSCREEN**            **ON|OFF or Yes|No**                            **Default: ON**

ON - The DISPLAY command generates four columns.  
OFF - The DISPLAY command generates one column.

When FSCREEN is set to ON, the command displays will list the present settings of commands in four columns across the screen. All text type of commands will start in column 1 to ensure the full text is displayed. This command expects an 80 column display.

When FSCREEN is OFF, all status information will be presented in a single long column.

**FULLDUPLEX ON|OFF or Yes|No                      Default: OFF**

- ON     - Full duplex mode is enabled.
- OFF    - Full duplex mode is disabled.

When full duplex mode (FULLDUP) is OFF, the packet controller makes use of the Data Carrier Detect signal from the modem to avoid collisions by only transmitting when the channel is clear. Multiple packets are acknowledged in a single transmission.

When FULLDUP is ON, the packet controller ignores DCD and transmits immediately whenever data or acknowledgements are packetized even if other frames are being received. Packets are acknowledged individually.

FULLDUP should only be used if both communicating stations are full-duplex stations.

**GPS    ON|exit character                      Default: OFF**

- ON     - The Asynchronous port is configured for GPS data.
- OFF    - The Asynchronous port is configured for a terminal.

The GPS command configures the packet controller to interface with a NMEA-0813 compatible Global Positioning System (GPS) receiver. When in GPS mode, all normal TNC commands are inoperative.

This command enables the GPS parser on the primary serial port. On dual serial port models, the GPS parser is enabled on the primary port and remains operative on the secondary port. *Normal operation for a two-port model with a terminal on Port 1 and a GPS receiver on Port 2 would call for GPS OFF.*

**NOTE:** To escape from GPS mode, the GPSEXIT character (default is backslash "\") must be sent over the serial input port. When in GPS mode, the packet controller may act "dead" to normal keyboard commands.

**GPSEXIT        n                      Default: \**

- n = 0 - \$7F, specifying an ASCII character code.

This command sets the value of the character recognized as the GPS exit character. There is no GPS OFF command. Once the GPS mode is ON, the GPSEXIT character must be used to get out of GPS mode.

The default value “\” was selected since this character does not appear in any NMEA GPS sentences. If GPSEXIT is set to a value which will appear in the normal serial data input stream, GPS mode will be exited unintentionally when that character appears.

**GPSITEXT**      **text**      **Default: blank**

text      - Up to 40 characters are sent to the attached GPS or LORAN immediately after the packet controller is powered on.

This command sets the setup string to be sent via the asynchronous port to the attached GPS or other device. There are no constraints on the content of the field except that the length may not exceed 40 characters. The GPSITEXT is only sent if GPS is ON and the GPSITEXT is not blank.

To clear the GPSITEXT without using the RESET command, enter a new GPSITEXT with a “%” or “&” as the first character in the text.

**GPSLIMIT**      **n**      **Default: 0**

n = 0-255      Maximum number of seconds GPS receiver will remain on if no fix.

GPSLIMIT sets the time limit in seconds that the GPS receiver's power will remain on in the event that a good fix has not been received. This prevents excessive power consumption in instances where the GPS antenna is blocked from receiving adequate satellite signals to obtain a fix.

When the number of seconds specified by GPSLIMIT has been reached, the GPS receiver will be turned off just as if a good fix had been received. Wake up time is set by the GPSSLEEP command.

A value of zero (0) disables this command. If disabled, the power to the GPS receiver will stay on indefinitely until a good fix is received if GPSSLEEP is allowing the GPS receiver to be active.

**GPSSLEEP**      **n**      **Default: 0**

n = 0-255      Number of seconds GPS receiver will remain powered off after a good fix is received.

The GPSSLEEP command sets the duration in seconds that the GPS will remain off after receiving a good fix. A value of zero (0) disables this function, thus keeping the GPS receiver constantly powered.

When power conservation is required in a GPS equipped packet controller, the GPSSLEEP and GPSLIMIT commands, used properly, can reduce power consumption by over 90%. GPSSLEEP specifies the time interval between attempts to get a GPS fix. Since GPSSLEEP specifies the off time for the GPS receiver, the actual interval between fixes will be the sum of the GPSSLEEP

setting and the time required for the GPS receiver to obtain a fix after a warm start.

**GPSTEXT**      **text**      **Default: \$GPGGA**

**text** - Any NMEA-0183 string identifier supported by attached GPS or LORAN receiver. The format is \$Gxxxx or \$Lxxxx.

This command sets the desired search pattern to be loaded into LTEXT. Conventional usage would be the \$Gxxxx or \$Lxxxx identifier corresponding to a valid GPS or LORAN output sentence, however this field may be set to any value desired (to a maximum of 9 characters).

For example, the value of "ERROR," entered into the GPSTEXT would cause the parser to search for the value "ERROR," (including the comma) and put the text ERROR, plus the following 120 characters into LTEXT.

To clear the GPSTEXT without using the RESET command, enter a new GPSTEXT with a "%" or "&" as the first character in the text.

**GPSTYPE**      **n**      **Default: 1**

**n = 0 -8** (see detailed descriptions below)

This command selects the type of GPS sentence or formatted string that is scanned for. String length is restricted to 70 characters. Consult the GPS/LORAN receiver documentation to determine which format is appropriate.

- 0 = This is an invalid setting, and will effectively disable the GPS mode and return the TNC back to normal command mode if GPS is turned on.
- 1 = This checks for the string type that has been entered into the GPSTEXT buffer. All characters are sent.
- 2 = This mode parses the \$GPGGA string in a special format.
- 3 = This mode parses the \$GPRMC string in a special format.
- 4 = This is the #L format. (No parsing done on this string)
- 5 = This is the 'FF' 'FF' '01' format. (No parsing done on this string)
- 6 = This is the STX ETX format. (No parsing done on this string)
- 7 = This is the # format. (No parsing done on this string)
- 8 = This mode parses the \$GPRMC string FIELDS 1-9.

◆ **GROUP**      **ON|OFF or Yes|No**      **Default: OFF**

**ON** - Group monitoring is enabled.  
**OFF** - Group monitoring is disabled.

The GROUP command enables monitoring of information transmitted for a selected group of stations. The value of MASTERM is used to determine the group and subgroup identifications which are monitored.

**HEADERLI ON|Off or Yes|No Default: OFF**

- ON - Address information for each line is displayed on the same line. OFF
- Address information for each line is displayed on its own line.

This command affects the display format. If HEADERLI is OFF, the address information is displayed with the packet:

**KV7D>N2WX:Go ahead and transfer the file.**

If HEADERLI is ON, the address information is displayed , followed by the packet text on a separate line:

**N2WX>KV7D:**

**Sorry, I'm not quite ready yet.**

**HEALED ON|Off or Yes|No Default: OFF**

- ON - The controller will "dither" the CON and STA LEDs.
- OFF - The CON and STA LEDs operate normally.

This command redefines the functions of the two CPU controllable LEDs (STAtus and CONnect) to indicate CPU activity.

When HEALED is set to ON, the two LEDs flash in alternate fashion indicating the firmware is executing and is not hung. When HEALED is set to OFF, the LEDs function normally, indicating a connection and any unacknowledged frames.

**H(ELP) or ?**

This command is used by an "over-the-air" PMS user. The HELP or ? command displays a list of PMS commands with a brief explanation of each.

- B(ye)** B[CR] disconnects you from PMS
- H(elp)** H[CR] or ?[CR] displays this help file
- J(log)** J[CR] displays a list of callsigns heard with date/time
- K(ill)** K n [CR] deletes message n (only to/from your callsign)
- KM** KM [CR] kills all messages to your callsign
- L(ist)** L [CR] lists the 10 latest messages
- M(ine)** M [CR] lists the 10 latest messages to/from your callsign
- R(ead)** R n [CR] reads message number n
- S(end)** S (callsign) (@BBS callsign) [CR] begins a message addressed to (callsign) at home BBS of (@ BBS callsign)  
Subject: maximum 70 characters ending with [CR]  
Text: end each line with [CR]. End message by typing /ex[CR] or CNTL-Z[CR] at the beginning of a new line.
- SB** Send bulletin
- SP** Send message marked Personal.
- SR n** Send reply to message number n.
- ST** Send message in NTS format.
- V(ersion)** V[CR] displays the software version of the PMS system.

## **HELP**

A help facility for the operator of the packet controller. The information provided varies from model to model. If the HELP function is not available, one of the following messages is displayed:

? unknown command or not implemented

## **HID ON|OFF or Yes|No Default: OFF**

ON - Enables HDLC identification by a digipeater.

OFF - Disables HDLC identification.

This command is used to enable or disable the sending of identification packets by the packet controller. If HID is OFF, the packet controller will never send an identification packet. If HID is ON, the packet controller will send an identification packet every 9.5 minutes if the station is digipeating packets. The ID command allows the operator to send a manual identification packet.

Identification consists of an unnumbered I (UI) frame whose data field is the station identification (the callsign as set by MYCALL) with "/R" appended. The identification packet is sent to the address in the UNPROTO command.

The QRA function is similar. If HID is on and a UI frame is received addressed to QRA-0, the TNC will respond after a random time of up to two minutes with an ID frame. If HID is off (default), QRA will never send an ID.

## **HOMEBBS callsign - n Default: none**

callsign - Up to six alphanumeric characters.

n - optional SSID from 0 to 15.

This command sets the callsign of the "home BBS" which forwards mail to your PMS or which you normally access manually.

## **ID**

ID is an immediate command which sends a special identification packet. ID can be used to force a final identification packet to be sent as a digipeater station is being taken off the air. The identification packet will be sent only if the digipeater has transmitted since the last automatic identification. See HID for ID frame information.

## **◆INPUT Pn Default: blank**

Pn - The hexadecimal number of the parallel IO port to be read.

This command reads the hexadecimal value of port n on packet modems equipped with parallel input/output ports. This command may be entered by the local keyboard or via an over the air remote command.

**•INTERVAL**                      **n**                      **Default: 0**

n = 0                      Function disabled  
 n = 1 – 250              Number of intervals to be silent

This command inhibits transmitting the UI Location Beacon frame for the number of beacon times that INTERVAL is set to. For example, if INTERVAL is set to 4 and LOCation is set to E 6, then the Location Beacon will be sent once, then the next four times skipped, and the following one sent.

Interval allows very infrequent beaconing beyond the maximum settings possible with LOC and LRANGE. Setting LOC =216 and LRANGE = 4 would give a location beacon every 6 hours (21600 seconds). If Interval was then set to 3, a location beacon would be sent once per 24 hours. INTERVAL =120 would give one location beacon each 30 days.

**J(log)**

A command used by a PMS over-the-air user to display a log of callsigns most recently heard. The number of entries in the display may vary based on PMS buffer space. A display example:

|        |      |          |       |
|--------|------|----------|-------|
| N4UQQ* | PMS  | 05/15/00 | 18:33 |
| TPA5   | NODE | 06/01/00 | 16:47 |
| K0ZXF  | BBS  | 00/00/00 | 00:00 |

Zeroes are shown in the date and time fields if the clock was not set. An asterisk ( \* ) means the station was heard via a digipeater.

**K**

K is a single letter alias for the Converse command. To enter Converse Mode from the command prompt simply enter K <CR>. See also CONVERSE.

**♦KEY**                      **n**                      **Default: blank**

n - the encryption key to be used. Maximum length 80 characters.

This parameter holds the key used by the encryption algorithm. It may be any length up to 80 characters. Longer keys provide more security. See ENCRYPT, and ENSHIFT for an explanation of the encryption system.

**KILL**                      **n**

A command used by a PMS over-the-air user to delete a message in the PMS. The abbreviation for this command is different from the "local" KILL command. *Using the abbreviated K command locally will place the TNC in Converse Mode.*

If the message is found and erased, the PMS will display:

**Message erased**

If an invalid message number is given, the PMS will display:

**Message not found**



KILL O(ld) will delete the 10 oldest messages.

**KILL**            **n**

**n**            - the number of the message you wish to kill.

This is a local command that allows deletion of a message in the PMS. If the message is found and erased, the PMS will display:

**Message erased**

If an invalid message number is given, the PMS will display:

**Message not found**

KILL O(ld) will delete the 10 oldest messages.

**KILONFWD**    **ON|OFF or Yes|No**                    **Default: ON**

**ON**            - Messages are deleted after forwarding.

**OFF**           - Messages are retained after forwarding.

This command selects whether messages which have been marked for reverse forwarding will be deleted or retained after forwarding takes place.

If KILONFWD is ON, messages are deleted after forwarding. If KILONFWD is OFF, messages must be manually deleted after forwarding.

**KISS**    **ON|OFF or Yes|No**                    **Default: OFF**

**ON**            - RESTART command initiates KISS firmware.

**OFF**           - RESTART command reinitiates standard packet firmware.

The KISS command sets the KISS parameter on in bbRAM. Then the RESTART command will cause the controller to initialize in the KISS mode.

The KISS mode may be exited by removing the battery jumper (which destroys bbRAM parameters) or by entering the command PARAM AX0 255 at the TCP/IP NET> prompt. To exit KISS when using an MS-DOS computer and communication software: 1) Hold down the ALT key; 2) Press keys 1 9 2 on the numeric keypad; 3) Release the ALT key; 4) Hold down the ALT key again; 5) Press keys 2 5 5 on the numeric keypad; and 6) Release the ALT key.

See also the MKISS command, which enters KISS mode immediately.

**KM**

A command used by a PMS over-the-air user.

This command means Kill Mine and "kills" all messages addressed to the user's callsign. See KILL command.

**LCALLS**      **call#1[, call#2, ...,call#8]**      **Default: blank**

**call** - Callsign list. Up to 8 calls, separated by commas. Each callsign may include an SSID specified as -n immediately following the call.

LCALLS works in conjunction with BUDLIST to allow selective control of which packets will be displayed when MONITOR is ON, which stations will be allowed to connect or digipeat through your station.

BUDLIST specifies whether the callsigns in the list are the ones you want to ignore or the only ones you want to monitor or to connect. If you want to monitor selected callsigns, enter those calls in LCALLS (separated by commas or spaces) and set BUDLIST ON. If you want to ignore selected callsigns, enter the calls to ignore selected callsigns, enter the callsigns to ignore in LCALLS and set BUDLIST OFF.

To clear LCALLS enter LCALLS %<CR> or LCALLS <CR>.

**LCOK**      **ON|OFF or Yes|No**      **Default: ON**

**ON** - The controller will send lower case characters to the terminal,  
**OFF** - Lower case characters are changed to upper case.

If LCOK is OFF, lower case characters will be translated to upper case before being output to the terminal. This case translation is disabled in Transparent Mode. Input characters and echoes are not translated.

Because echoes of the characters typed in are not translated to upper case, if both operators set LCOK to OFF, each operator can type messages in lower case and see incoming packets displayed in upper case.

**LCSTREAM**      **ON|OFF or Yes|No**      **Default: ON**

**ON** - The character immediately following the STREAMSW character is converted to upper case before processing it.  
**OFF** - The character after STREAMSW is processed as entered.

When using multiple connections, the user must enter an UPPER CASE stream identifier (A, B, C etc.) after the STREAMSW character (default | ) to select a new logical stream to send commands or send data. Setting LCSTREAM ON allows the STREAMSW character to be entered in lower case.

**LFADD**      **ON|OFF or Yes|No**      **Default: ON**

**ON** - A Linefeed <LF> character is added to outgoing packets following each <CR> transmitted in the packet.  
**OFF** - No <LF> character is added to outgoing packets.

This function is similar to AUTOLF, except that the <LF> characters are added to outgoing packets rather than to text displayed locally. If the receiving station reports overprinting of packets from your station, set LFADD to ON. This command is disabled in Transparent Mode.

**LFIGNORE**    **ON|OFF or Yes|No**                      **Default: OFF**

- ON     - Line Feed characters <LF> are ignored.
- OFF    - Line Feed characters <LF> are acted upon.

This command controls whether the packet controller responds to ASCII Line Feed (\$0A) characters in Command and Converse modes. The LFIGNORE command is useful when incoming data has embedded Line Feed characters that cause double spacing of the data on your screen or printer.

When LFIGNORE is ON, line feeds are totally ignored. When turned off, line feed characters are processed normally.

**LGETCHAR**    **none**    **Default: \$00**

This command sets the value of the 'hot key' character used to dump the GPS capture buffers to the serial port. The LGETCHAR will always send the data that is in the LTEXT, L1TEXT, L2TEXT, and L3TEXT fields to the terminal port. If the ELOC value is set to 2, then the LGETCHAR will also send the GPS capture buffers to the RF port. **NOTE:** This command is only functional on dual-serial port TNCs. LGETCHAR should be set to \$05 for APRS use.

- LG1TEXT**      any    **Default: \$GPVTG**
- LG2TEXT**      any    **Default: blank**
- LG3TEXT**      any    **Default: blank**

These fields (and GPSTEXT) specify the NMEA GPS sentences to be parsed. They may be set to any value, such as required for weather station support, etc.

The GPS parser places the string specified in GPSTEXT into LTEXT, thus saving BTEXT for normal beacons. Similarly LG1TEXT is stored in the L1TEXT capture buffer, LG2TEXT in L2TEXT, etc.

These fields, LG1text, LG2text, and LG3text may be cleared by entering the command followed by a "%" symbol and a <CR>.

**LIST**

This command lists all messages in the PMS. A typical display:

| Msg # | Stat | Date     | Time  | To    | From   | @ BBS   | Subject   |
|-------|------|----------|-------|-------|--------|---------|-----------|
| 3     | P    | 07/16/94 | 09:23 | WIBEL | K0ZXF  | @ W4DPH | Hello     |
| 2     | PF   | 07/15/94 | 23:45 | K0ZXF | WIBEL  | @ K0ZXF | Bulletins |
| 1     | B    | 07/13/94 | 03:52 | ALL   | N4UQQ@ | W4DPH   | Help      |

15003 Bytes free  
Next message Number 4  
cmd:

The values for Status are B(ulletin), P(riivate or Personal), and T(NTS Traffic).

Messages to "ALL" will have P(riivate) status but will be readable by all users.

**LIST**

This command used by a PMS over-the-air. A typical display:

| Msg # | Stat | Date     | Time  | To    | From  | @ BBS   | Subject   |
|-------|------|----------|-------|-------|-------|---------|-----------|
| 3     | P    | 07/16/94 | 09:23 | W1BEL | K0ZXF | @ W4DPH | Hello     |
| 2     | PF   | 07/15/94 | 23:45 | K0ZXF | W1BEL | @ K0ZXF | Bulletins |
| 1     | B    | 07/13/94 | 03:52 | ALL   | N4UQQ | @ W4DPH | Help      |

15003 Bytes free

Next message Number 4

cmd:

The values for Status are **B**(ulletin), **P**(rivate or Personal), and **T**(NTS Traffic). Messages to "ALL" will have a P(rivate) status but will be readable by all users.

**LOCATION Every|After n Default: E 0**

|       |  |
|-------|--|
| EVERY | - Send location beacon at regular intervals.   |
| AFTER | - Send location beacon after interval with no activity.<br>n = 1 - 250, location beacon timing in 10 second intervals.<br>n = 0 disables location beacons. |

This command enables sending of location beacons and causes the first location beacon frame to be transmitted. A location beacon frame consists of the non-blank contents of LTEXT, L1TEXT, L2TEXT and L3TEXT in a packet addressed to "GPS" and sent via the call string specified by the LPATH command.

If the keyword EVERY is specified, a location packet is sent every n \* 10 seconds. If AFTER is specified, a location packet is sent only after n \* 10 seconds have passed with no packet activity. In this case, the location packet is sent only once until further activity is detected. This mode may be used to send location packets only when packet stations are on the air.

Only those fields containing data will be sent. If LTEXT, L1TEXT, L2TEXT and L3TEXT are all blank, no location beacons will be sent.

The LOCATION function operates identically to the BEACON function but is entirely separate. If no GPS or LORAN is connected to the packet controller, the LOCATION, LTEXT/L1/L2/L3TEXT capture buffers, and LPATH commands may be used as a second text beaconing system.

**LOGONMSG ON|OFF or Yes|No Default: ON**

|     |  |
|-----|--|
| ON  | - The standard PMS log-on message is sent.     |
| OFF | - The standard PMS log-on message is not sent. |

This command controls sending of the standard PMS log-on message. It has no effect on the custom message contained in STEXT. If LOGONMSG is ON, the following message is sent:

\*\*\* CONNECTED TO (PMS callsign)  
Logged on to (PMS callsign)'s Personal Message System  
Optional PMS system operator supplied message (STEXT)  
CMD(B/H/J/K/KM/L/M/R/S/SR/V/?)>

If LOGONMSG is OFF, the sign-on appears as follows:

\*\*\* CONNECTED TO (PMS callsign)  
Optional PMS system operator supplied message (STEXT)

CMD(B/H/J/K/KM/L/M/R/S/SR/V/?)>

**LPATH call#1 [Via call#2[,call#3...,call#9] Default: APRS VIA WIDE**

call#1 - Callsign to be placed in the TO address field.

call#2-9 - Optional digipeater call list, up to eight calls.

LPATH (Location Beacon Path) is analogous to UNPROTO - the path by which location beacons will be sent. [Beacons go out via UNPROTO, locations go out via LPATH].

This command sets the digipeat and destination address fields of packets sent by the LOCATION command in the unprotocol mode. Location packets are sent as unnumbered 1 (UI) frames with the destination and digipeat fields taken from call1 through call9 options. The default 'to' for UI packets is GPS.

Note that all UI frames except location frames are addressed by the UNPROTO command

**LRANGE n Default: 3**

|       |  |
|-------|--|
| n = 1 | Not supported.                             |
| 2     | 1 second                                   |
| 3     | 10 seconds (default and traditional value) |
| 4     | 100 seconds                                |

LRANGE sets the location beacon timer increment or multiplier value. This value is the amount by which the location beacon timer increments after each location beacon is sent. The LRANGE command allows location beacons to be sent from once per second to approximately once per 7 hours.

For example, with LRAnge set to 2, L E 1 (location every one) will cause a location beacon to be transmitted each second. If LRAnge is set to 4, the L E 1 command will trigger a location beacon every 100 seconds. (See BRANGE for beacon timing increments).

**LSLOT**

n = 0-59 selecting the second assigned for transmitting the Location Beacon.  
A value of 60 disables the function.





If MALL is OFF, only eligible UI (unconnected) packets (determined by BUDLIST and LCALLS) are displayed.

If MALL is ON, all otherwise eligible frames are displayed, including connected frames sent between two other packet controllers.

**◆ MASTERM n Default: blank**

n = two characters defining the Master Group and Subgroup..

The value of MASTERM is used to select which frames to monitor when the GROUP command is ON. The receiving packet modem compares the value of MASTERM with the first two characters of the call sign in the 'from' field of each received frame. If both characters match, the frame will be displayed.

**MAXFRAME n Default: 4 [HF 1]**

n = 1 - 7, signifying a number of frames.

MAXFRAME sets a limit on the number of unacknowledged frames which may be outstanding at any time. This is also the maximum number of contiguous packets which can be sent during any transmission.

File transfers and other 'high volume' data applications require different values for MAXFRAME and PACLEN than used for interactive communication. The values should also be changed based on the quality of the RF link. A value of 1 is recommended for HF or other weak signal work and for busy channels.

**MCOM ON|OFF or Yes|No Default: OFF**

ON - All frames are monitored.  
OFF - Only information frames are monitored.

MCOM enables the display of control frames when MONITOR is ON.

When MCOM is ON all control fields are decoded and invalid ones are marked with ????. For I and S frames, sequence number information is also presented. Frames compatible with AX.25 Level 2.0 are also decoded as to the state of the C and PF bits. See the Protocol Chapter for more information.

When MCOM is OFF, only packets with user information will be displayed.

**MCON ON|OFF or Yes|No Default: OFF**

ON - Monitor mode remains active when in connected state.  
OFF - Monitor mode is off when in connected state.

If MCON is ON, the MONITOR command will enable monitoring while the packet controller is in the connected state on this stream. Thus a mixture of connected and monitored frames will be displayed.



If MCON is OFF, the display of monitored packets is suspended when a connection occurs, and is resumed when disconnected on this stream.

**MFILTER**     n1[,n2 [,n3 [,n4]]]                     **Default: 00 (null)**

n1, n2, n3, n4 = 0 - \$7F, specifying ASCII character codes to be filtered.

This command specifies characters to be "filtered", or eliminated from monitored packets. The code may be entered in either hex or decimal.

For example, if you want to filter the <CTRL-L> screen clearing character, you can set MFILTER 12. If you also want to eliminate <CTRL-Z> characters (end-of-file markers) you can set MFILTER 12,26.

Clear the MF list by the command MFILTER 00. Any characters following 0 or \$00 in the MFILTER string will be ignored.

**MHCLEAR**

MHCLEAR is an immediate command causing the MHEARD list to be cleared. Clear the MHEARD list when you first begin to monitor the packet activity to keep track of the stations on the air over a given period of time.

**MHEARD**

MHEARD is an immediate command. It causes the display of the list of stations heard since the last time the command MHCLEAR was given.

Stations that are heard via digipeater are marked with \*. The maximum number of stations logged is 18. As more stations are heard, earlier entries are dropped. Logging is disabled when PASSALL is ON. If the date and time are set, entries in the heard log will be time stamped. Stations which can be identified by their transmissions as a PMS, BBS, or NODE are so listed in the heard log.

```

cmd:MHEARD
W4DPH-15          BBS    04/30/00  17:31:12
W8DUV*           BBS    04/30/00  17:26:14
CLW5             NODE   04/30/00  16:55:00
W4MUA-1         04/30/00  16:46:23

```

**MINE**

Lists all messages to or from your PMS callsign (MYPCALL). For example, if MYPCALL is set to WIBEL, MINE will show the following messages from the example shown above in the LIST command:

```

Msg # Stat Date   Time      To      From      @ BBS      Subject
   3 P  04/16/93 09:23  WIBEL  K0ZXF    @ W4DPH    Hello
   2 PF  04/15/93 23:45  K0ZXF  WIBEL    @ K0ZXF    Bulletins

```

15003 Bytes free  
Next message Number 4  
cmd:



**MSGHDR**    **ON|OFF or Yes|No**                    **Default: ON**

- ON        - Forwarded messages will have a message header inserted.
- OFF       - Forwarded messages will not have a message header.

MSGHDR selects whether forwarded messages have a message header inserted at the start of the message. The message header appears as follows:

**Originated From: <callsign> mm/dd/yy hh:mm Msg # n**

The format of the date depends on the setting of the DAYUSA command.

**MSGROUTE**    **ON|OFF or Yes|No**                    **Default: OFF**

- ON        - PMS messages contain the complete BBS routing history.
- OFF       - PMS messages have the BBS routing history purged.

This command allows reducing the size of stored PMS messages by eliminating lengthy lists of BBS routing history.

When MSGROUTE is ON, all lines of BBS routing history are retained in the PMS message. When MSGROUTE is OFF, only the first and last lines of the history are retained in the PMS message.

**MSTAMP**        **ON|OFF or Yes|No**                    **Default: OFF**

- ON        - Monitored frames are time stamped.
- OFF       - Monitored frames are not time stamped.

This command enables time stamping of monitored packets. The date and time are set by the DAYTIME command, and the date format is determined by the DAYUSA command. For example:

**WB9FLW>AD7I,K9NG\*,N2WX-7[05/24/97 16:53:19]:Hi Paul.**

**MTRANS**        **ON|OFF or Yes|No**                    **Default: OFF**

- ON        - Monitoring is enabled when in Transparent mode.
- OFF       - Monitoring is disabled when in Transparent mode.

This command enables monitoring when in Transparent mode.

When CONMODE is set to TRANS and the controller is in data transfer mode, (whether connected or unconnected) monitoring is disabled. This is an automatic feature to insure that connected data transfer is completely transparent for both transmit and receive.

When binary data need to be sent in unconnected mode, CONMODE must still be set to TRANS to insure transparency of transmitted data. In this case, setting MTRANS ON will override the CONMODE and allow reception of unconnected frames. See also DATAMODE/UI MODE.

|                 |                 |                      |
|-----------------|-----------------|----------------------|
| <b>MYALIAS</b>  | <b>call[-n]</b> | <b>Default: none</b> |
| <b>MY1ALIAS</b> | <b>call[-n]</b> | <b>Default: none</b> |
| <b>MY2ALIAS</b> | <b>call[-n]</b> | <b>Default: none</b> |
| <b>MY3ALIAS</b> | <b>call[-n]</b> | <b>Default: none</b> |

call - Alternative identity of the packet controller.  
n - 0 - 15, an optionally specified sub-station ID (SSID).

These commands specify alternate callsigns (in addition to the callsign specified in MYCALL) for digipeater use.

MYALIAS is the primary alias callsign for digipeating. MY1ALIAS, MY2ALIAS, and MY3ALIAS are additional alias callsigns for digipeating.

The "alias" commands permit HID to identify normally with the MYCALL-specified callsign, yet permit an alternate (alias) digipeat-only "callsign".

|               |                 |                          |
|---------------|-----------------|--------------------------|
| <b>MYCALL</b> | <b>call[-n]</b> | <b>Default: NOCALL-0</b> |
|---------------|-----------------|--------------------------|

call - Callsign of the packet controller.  
n - 0-15, an optionally specified sub-station ID (SSID).

The MYCALL command tells the packet controller its callsign. It is placed in the FROM address field for all packets it originates, including HID and ID.

The packet controller accepts connected frames with this callsign in the TO field and relays frames with this callsign in any of the digipeat fields.

The sub-station ID (SSID) is used to distinguish two stations with the same call. The SSID will automatically be set to zero (0) unless explicitly set to another value. There should never be more than one station with the same callsign (including SSID) on the air at once. It is normal practice to set MYCALL and MYPCALL to the same callsign but with different SSIDS.

|                |                 |                      |
|----------------|-----------------|----------------------|
| <b>MYPCALL</b> | <b>call[-n]</b> | <b>Default: none</b> |
|----------------|-----------------|----------------------|

call - Up to six alphanumeric characters.  
n - 0 - 15, an optionally specified sub-station ID (SSID).

This command sets the callsign of the Personal Message System (PMS), which **MUST NOT be identical to MYCALL**. It is standard practice to use the "same" callsign with different SSIDs for both MYCALL and MYPCALL.

The PMS will respond to connect requests to MYPCALL and will use MYPCALL for the "from" callsign in originated messages.

|               |                 |                      |
|---------------|-----------------|----------------------|
| <b>MYROSE</b> | <b>call[-n]</b> | <b>Default: none</b> |
|---------------|-----------------|----------------------|

call - Up to six alphanumeric characters.  
n - 0 - 15, an optionally specified sub-station ID (SSID).

This command sets the callsign of the local ROSE node.

**NEWMODE**    **ON|OFF or Yes|No**                    **Default: OFF**

- ON        - Entry to data transfer mode when the CONNECT command is given: return to Command Mode is automatic at disconnection.
- OFF       - Switching to data transfer mode occurs at connection but no return to Command Mode occurs at disconnection.

The NEWMODE command may be used to select the way the controller behaves when connections are made and broken.

If NEWMODE is OFF, the packet controller will remain in Command Mode after you issue a CONNECT command until a connection is actually established. The packet controller will then enter Converse or Transparent Mode, depending on the setting of CONMODE. When the connection is terminated, the packet controller remains in Converse or Transparent Mode until you force it to return to the Command Mode (see COMMAND).

If NEWMODE is ON, the packet controller will enter into the mode specified in CONMODE as soon as you issue a CONNECT command, without waiting for the connection to be established. Anything typed thereafter will be packetized to be transmitted once the connection is complete. When the connection is broken, or if the connect attempt fails, the packet controller returns to the Command Mode automatically.

**NODETEXT**    **text**    **Default: blank**

text - A valid connect string (limited to one digipeater).

The NODETEXT field should be filled with a valid connect string or left blank. This connect string is used by the FNPMS and RFPMS commands to cause the node or switch in use to connect to the desired station for message forwarding. The NODETEXT should contain the CONNECT command followed by the callsign of the station to be forwarded to. Only one digipeater field may be included and must be preceded by the V(ia) command. (See the CONNECT command for examples of a proper connect string).

The NODETEXT field may be cleared by typing the command NOD % <CR>.

**NOMODE**        **ON|OFF or Yes|No**                    **Default: OFF**

- ON        - The controller will only switch modes upon explicit command.
- OFF       - The controller switches modes in accordance with NEWMODE.

When NOMODE is ON, the packet controller will never change between Converse or Transparent Mode to Command Mode (or vice versa) on its own. Only user commands (CONV, TR, or CNTL-C) may change the mode.

If NOMODE is OFF, the automatic mode switching is handled according to the setting of the NEWMODE command.

**NUCR**                    **ON|OFF or Yes|No**                    **Default: OFF**

ON    -<NULL> chars are sent to the terminal after <CR>.

OFF   -<NULL> characters are not sent after <CR>.

This command causes transmission of <NULL> characters (ASCII code \$00), producing an effective delay following any <CR> sent to the terminal. The number of <NULL> characters is determined by the command NULLS . This delay is required by some hardcopy terminals to allow time for the carriage to return and the paper to advance. Set NUCR ON if your terminal omits characters after a <CR>.

**NULF**                    **ON|OFF or Yes|No**                    **Default: OFF**

ON    - <NULL> characters are sent after <LF> characters.

OFF   - <NULL> characters are not sent after <LF> characters.

This command causes transmission of <<NULL>> characters (ASCII code \$00), producing an effective delay following any <<LF>> sent to the terminal. The number of <<NULL>> characters is determined by the command NULLS. Devices requiring nulls after <<LF>> are typically mechanical printers. Set NULF ON if your printer misses characters at the beginning of the line.

**NULLS**                    **n**                    **Default: 0**

n = 0 - 30, the number of nulls added after a <CR> or <LF>.

This command specifies the number of <NULL> characters (ASCII code \$00) to send to the terminal after a <CR> or <LF> is sent. In addition to setting this parameter value, NUCR and/or NULF must be set to indicate whether nulls are to be sent after <CR> , <LF>, or both.

Extra null characters are sent only in Converse and Command Modes. Devices requiring nulls are defined in the NULF and NUCR commands.

**◆OUTPUT**                    **Pn,m**                    **Default: blank**

Pn - The hexadecimal number of the parallel IO port to be written.

m - The hexadecimal value to be output via port Pn

This command outputs the hexadecimal value m to output port n on packet modems equipped with parallel input/output ports. This command may be entered by the local keyboard or via an over the air remote command.

**PACLEN**                    **n**                    **Default: 128 (may vary)**

n = 0 - 255, specifying the maximum length of the data portion of a packet.

The value 0 is equivalent to 256. Commercial models support a paclen of 1024

The controller will automatically transmit a frame, when the number of input bytes for a packet reaches n in either Converse or Transparent Modes.

PACLEN defaults to 128 characters. Set PACLEN to 0 for maximum data transfer rate when good signals exist. (Some models support a maximum PACLEN of 1024 for use with faster RF speeds.)

Set PACLEN to a smaller value such as 40 for poor quality RF circuits. This will cause a larger number of small frames to be sent, and small frames have less exposure to noise and interference, thus improving their likelihood of being received successfully.

**PACTIME**      Every|After      n      **Default: After 10**

- Every - Packet timeout occurs every n \* 100 milliseconds.
- After - Packet timeout occurs when n \* 100 mS elapse with no input.
- n - 0 -250, specifying 100 ms intervals.

This parameter is always used in Transparent Mode, and is used in Converse Mode if CPACTIME is ON. When "Every" is specified, input bytes are packaged and queued for transmission every n \* 100ms. When "After" is specified, bytes are packaged when input from the terminal ceases for n \* 100ms.

A zero length packet is never produced, and the timer is not started until the first byte is entered. If n = 0, packets are generated with no wait time.

**PARITY**                      n                      **Default: 0 (none)**

- n = 0 - 3, selecting a parity option according to the following code: 0 = none, 1 = odd, 2 = none, 3 = even.

This command sets the parity mode for terminal or computer data transfer. The parity bit, if present, is automatically stripped on input and not checked in Command Mode and Converse Mode unless 8BITCONV is ON and AWLEN is set to 8.

In Transparent Mode, all eight bits, including parity if any, are transmitted in packets. If "no parity" is set and AWLEN is 7, the eighth bit will be set to 0 in Transparent Mode.

**PASS**                      n                      **Default: \$16 [CNTL-V]**

- n = 0 - \$7F, specifying an ASCII character code.

PASS selects the ASCII character used as the "PASS character" The parameter n (hex or decimal) is the ASCII code to be used as the pass character.

Use the pass character to send any character in a packet, even if it has some special function for the packet controller, e.g. allow <CR> to be included in the BTEXT, CTEXT, and STEXT. You also can include <CR> in text when you are in Converse Mode, to send multi-line packets.

**PASSALL      ON|Off or Yes|No      Default: OFF**

ON      - Controller displays packets with valid or invalid CRCs.

OFF      - Controller displays only packets with valid CRCs.

This command allows display of packets received with invalid CRC fields if they consist of an even multiple of 8 bits and up to 339 bytes. The display shows the call sign(s) in standard monitor format, followed by the packet data.

Logging of stations heard (for display by MHEARD) is disabled whenever PASSALL is ON, because the call signs detected may be incorrect.

Monitoring a moderately noisy channel with PASSALL on will periodically cause "pseudo-packets" generated by noise to be displayed.

**PASSWD      text      Default: password**

Text = up to 80 characters which is the password for remote operations.

The PASSWD command is used to set the password in the remote TNC. If the PASSWD field is blank, then the TNC will function without any password protection. The default value of PASSWD is: PASSWORD. If this field is set over the RF link, the entire password must be sent and received in a single packet, in other words PACLEN must be greater than 80 for it to work.

When a connection is made to the remote TNC's RMTCALL call sign, the TNC selects five random letters from the stored password (PASSWD), and sends the Remote Operator a Password Query String which consists of five decimal numbers that correspond to the position of these letters in the stored password. The Remote Operator must respond with the corresponding five letters to gain access to the TNC.

If the correct Response String to the Password Query String is entered, the TNC will respond by sending a cmd: prompt. If an incorrect response is entered, the TNC will disconnect. The Response String may contain leading and trailing camouflage characters. However, the correct five characters must be included in the entered string in the order specified by the Password Query String. The *password search is case sensitive*.

For example, if using the default password of PASSWORD, the Remote TNC might send a Password Query String of 01 08 05 06 02. The operator would enter PDWOA to gain access to the TNC.

The operator may elect to append leading and trailing camouflage characters, if desired, and thus enter: oiJitPDWOAKjhNHCYfa and also gain access to the Remote TNC.





**PPERSIST      Discontinued Command**

The PPERSIST command is no longer supported in PacComm firmware. The command may be present in some firmware versions, but is not operative.

**PPRINT                      n or n - n**

- |       |  |
|-------|--|
| n     | - PMS message number to be sent to printer port.           |
| n - n | - Range of PMS message numbers to be sent to printer port. |

This command allows the printing of Personal Message System (PMS) messages to a printer attached to the PacComm printer port.

For example, to print messages 15 through 20, give the command:

**cmd: PPRINT 15-20**

**PRAUTOLF      ON|OFF or Yes|No                      Default: ON**

- |     |  |
|-----|--|
| ON  | - A linefeed <LF> is sent after each <CR>.   |
| OFF | - Carriage return <CR> characters are sent to the printer without an appended linefeed <LF> character. |

If the printer requires a linefeed character with each carriage return, set PRAUTOLF to ON.

If printing is double spaced and should be single spaced, set PRAUTOLF OFF.

**PREFIX                      n                      Default: \$00 (null)**

- |             |  |
|-------------|--|
| n = 0 - 255 | value of the character to be prefixed to each monitored frame. |
|-------------|--|

This command sets the value of the PREFIX character. When not set to 00 (null), this character is output as the first character of each monitored frame. Frames received from connected streams are not affected.

This may be used by terminal programs to direct monitored frames to a separate window. Another usage is to set PREFIX to the tab character which will cause each monitored frame to begin on an indented line.

**•PRINT                      ON|OFF or Yes|No                      Default: OFF**

- |     |                                 |
|-----|---------------------------------|
| ON  | - The printer port is enabled.  |
| OFF | - The printer port is disabled. |

This command allows the printer port functions to be enabled or disabled.

If PRINT is OFF, no printing will occur under any condition. If PRINT is ON, printing will be controlled by the link connection state and the PRTTGL state.

**•PRPAGE                      ON|OFF or Yes|No                      Default: ON**

- |     |   |
|-----|---|
| ON  | - The printer output will automatically be paginated. |
| OFF | - The printer output will be non-paginated.           |

This command is used in conjunction with the PRPGLN command to paginate printed output.

If the printer automatically paginates printer data, or if no pagination is desired, set PRPAGE OFF. If PRPAGE is ON, a formfeed character will be sent to the printer after PRPGLN number of line has been printed.

**•PRPDISC    ON|OFF or Yes|No                    Default: ON**

|     |  |
|-----|--|
| ON  | - A formfeed character will be sent to the printer when the link state becomes disconnected. |
| OFF | - No formfeed character will be sent to the printer.   |

When PRPDISC is ON, a formfeed character is sent to the printer at the end of each connection to allow the printer to begin printing at the top of page position each time a connection is established.

**•PRPGLN        n    Default: 60**

|   |  |
|---|--|
| n | - number of lines printed between formfeed characters. |
|---|--|

This command sets the number of lines to be printed on each page. The PRPGLN value is used by PRPAGE to paginate output.

**•PRTTOFF       n    Default: \$0F**

|   |
|---|
| n = 0 - \$7F, specifying an ASCII character code. |
|---|

The PRTTOFF command sets the value of the character in received data which is used to toggle printer output off. See PRTTGL.

**•PRTTON        n    Default: \$10**

|   |
|---|
| n = 0 - \$7F, specifying an ASCII character code. |
|---|

The PRTTON command sets the value of the character in received data which is used to toggle printer output on. See PRTTGL.

**•PRTTGL        ON|OFF or Yes|No                    Default: ON**

|     |   |
|-----|---|
| ON  | - Printer output controlled by PRTTON and PRTTOFF characters. |
| OFF | - Printer output occurs for all data in Converse Mode.        |

PRTTGL controls whether printer output is controlled by PRTTON and PRTTOFF commands embedded in the received Converse Mode data.

**•PRTUIFRA    ON|OFF or Yes|No                    Default: OFF**

|     |   |
|-----|---|
| ON  | - Monitored UI (Unnumbered Information) frames are printed. |
| OFF | - Only connected frames are printed.                        |

The PRTUIFRA command allows printing of received UI frames. Frames are printed without callsign address headers to allow the "reconstruction" of text or graphics documents. PRTUIFRA should be used in conjunction with LCALLS and BUDLIST to limit data received to only one station.

The CRAFT command controls whether a carriage return <CR> character is appended to the end of each monitored frame.

**ORA** See HID

**READ** n or n - n

- n - The number of the PMS message to be read.
- n - n - The first and last numbers of the messages to be read.

This command displays message number n in the format below:

```
Stat      : P
Posted   : 07/15/97 19:33
To       : K4NTA
From     : W1BEL
@ BBS    : K0ZXF
BID      :
Subject  : FADCA Meeting
```

Text of message.

If the READ command is given without a number, a listing of messages in the PMS will be displayed (same as LIST command).

Reading any PMS message (not necessarily a newly entered message) will reset the blinking PMS or STA LED.

**RECONNECT** call#1[Via call#2 [,call#3...,call#9]]

- call#1 - Callsign to be reconnected to.
- call#2 - Optional digipeater callsign(s) separated by spaces or commas.

RECONNECT is an immediate command. It may be used to change the path through which you are currently connected to a station. It may only be used when the packet controller is connected on the current stream to the station to which you wish to reconnect.

The integrity of outstanding frames at the time of reconnect is not assured. For details of the parameter list, see the Connect command.

**REDISPLAY** n Default: \$12 [CNTL-R]

n = 0 -\$7F, specifying an ASCII character code.

This command is used to select the redisplay-line input editing character. The parameter n (hex or decimal) is the ASCII code for the character you type in order to redisplay the current line.

When you type the redisplay-line character, type-in flow control is temporarily released (if it was enabled), displaying any incoming packets that are pending. Then a <BACKSLASH> “\” character is typed, and the line you have begun is

redisplayed on the next line. If you have deleted and retyped any characters, only the final form of the line is shown.

Use the redisplay-line character to see a "clean" copy of your input with a printing terminal after deleting characters. If you have set BKONDEL OFF, deletions are designated with <BACKSLASH> characters, rather than by trying to correct the input line display.

**REMOTE      ON|OFF or Yes|No      Default: OFF**

|     |  |
|-----|--|
| ON  | - Remote commanding function is enabled. |
| OFF | - Remote command function is disabled.   |

This command enables and disables the Remote Commanding feature, which allows complete setup and control of a packet controller over an RF link.

When REMOTE is set ON and RMTCALL is set, a remote connection may be made to the TNC's RMTCALL to issue and view the output from TNC commands. All commands may be executed remotely except:

- No callsign changes for MYCALL or RMTCALL will be honored.
- PMS should not be accessed. Some PMS commands may function properly under these conditions, others may fail. The proper way to access all PMS commands is by connecting to the PMS callsign and using the Remote SYSOP function.
- You should avoid use of the DISPLAY command and instead use subsets of that command, such as DISP H, DISP T, etc. If you use the DISPLAY command you will get approximately 300 bytes of data and then nothing else. Sending a <CR> (empty frame) will restore the cmd: prompt.
- The HELP command (not available on all products) is subject to the same constraints as the DISPLAY command.

**REMSYSOP    ON|OFF or Yes|No    Default: OFF**

|     |   |
|-----|---|
| ON  | - The MYPCALL is allowed SYSOP privileges over the air.     |
| OFF | - The MYPCALL is not allowed SYSOP privileges over the air. |

When REMSYSOP is ON, the callsign contained in MYPCALL is allowed to READ and KILL any message via the radio port. This allows the SYSOP to remotely manage the message base in the PMS equipped packet controller.

**RENUMBER**

RENUMBER is an immediate command which allows the PMS SYSOP to renumber the messages currently in the PMS message base. The messages will be renumbered starting with the number 1.



**RFPMS call#1 [Via call#2]**

call#1 - Callsign of PMS station to be connected to.  
call#2 - Optional callsign of station to be digipeated through.

This command causes the PMS to connect to a switch or node (call#1) via no more than one digipeater (call#2). The callsign string may not exceed 23 characters. Once the connection exists, the PMS sends the node the connect string contained in NODETEXT to cause the node to connect to the desired PMS station. Once the connection to the slave PMS is established, the slave PMS is commanded to upload all messages marked for forwarding.

If the station connected to by the RFPMS command is not a PMS station capable of forwarding messages, or if a forwarding protocol error is detected, automatic disconnection occurs.

**RFPMS call#1 [Via call#2]**

call#1 - Callsign of PMS station to be connected to.  
call#2 - Optional callsign of station to be digipeated through.

This command causes the PMS to connect to another PMS station (call#1) via no more than one digipeater (call#2). The callsign string may not exceed 23 characters.

Once the connection to the slave PMS is established, the slave PMS is commanded to upload all messages marked for forwarding. If the station connected to is not a PMS station capable of forwarding messages, or if a forwarding protocol error is detected, automatic disconnection occurs.

**RMTCALL call[-n] Default: blank**

call - Callsign of the packet controller.  
n - 0-15, an optionally specified sub-station ID (SSID).

This command sets the callsign of the Remote Command Function of the packet controller. It should NOT be identical to MYCALL.

The password protected remote commanding allows complete setup and control of the packet controller over the RF link. See the REMOTE command.

**RTCSYNC ON|OFF or Yes|No Default: OFF**

ON - Packet controller seconds are updated from GPS sentence.  
OFF - Packet controller seconds are updated by controller firmware.

The RTCSYNC (Real Time Clock Synchronization) command updates the seconds field of the packet controller's software clock to match the time received from GPS satellites. The minutes and hours are not affected thus preserving the local time zone entered by the packet controller operator.

The clock is updated to GPS time once per minute if GPSSLEEP is OFF, and on every fix if GPSSLEEP is ON. RTCSYNC uses the \$GPGGA sentence, but it is not necessary for any of the GPS capture buffers to be scanning for the GGA sentence. Of course the GPS receiver must output the GGA sentence.

If a hardware clock chip is installed it is automatically updated from the software clock by the packet controller firmware.

**RXBLOCK    ON|OFF or Yes|No                    Default: OFF**

|     |  |
|-----|--|
| ON  | - The controller sends data to the terminal in RXBLOCK format. |
| OFF | - The controller sends data to the terminal in normal format.  |

RXBLOCK is designed for automated operations, such as packet bulletin board stations. It helps such systems discriminate between data received from the connected station and packet controller generated messages.

Correct operation of RXBLOCK is dependent on the AWLEN parameter being set to 8 bits because the character FF hex marks the beginning of a received data unit header.

When RXBLOCK is on, data from other stations will be sent from the packet controller in the following format:

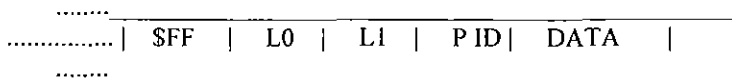

..... The fields above are defined as follows:

- Prefix..... \$FF::= A character with all 8 bits set
- Length..... L0::= The high order data length, length and PID fields  
..... logically ORed with \$F0
- ..... L1::=The low order data length, length, and PID fields
- PID..... PID::= The Protocol Identifier byte received for the  
..... following data field
- Data..... DATA::=[Optional], variable data length

For best operation, parameters like AUTOLF, MFILTER, etc should be set to OFF to prevent uncertainties in the size of the data field.

**SB**

This is an extension of the PMS SEND command. SB causes the message status to be marked with a B designator denoting BULLETIN.

Refer to the SEND command for detailed instructions.



**SCREENLN n Default: 0**

n = 0 - 255, specifying the character with of the terminal screen.

This command formats terminal output by specifying the length of each line of text displayed. A <CR><LF> sequence is sent to the terminal in Command and Converse Modes after n characters have been sent. N = 0 inhibits this action.

If the computer automatically formats output lines, leave SCREENLN set to 0.

**SEND to-call-n @ call-n \$ BID**

to-call - Callsign to which you wish the message addressed.  
@-call - The "home BBS" callsign of the station to which the message is sent (if known).  
n - Optional SSID.  
\$ \_BID - Optional Bulletin Identifier.

This command begins the procedure for creating a message addressed to "to-call". Addressing messages to "ALL" is permitted. If the operator does not enter a callsign, the message will be addressed to MYPCALL, the PMS callsign.

The HOMEBBS callsign (if known) should be included as shown above in the command format as @call. The @ symbol must be typed between the callsigns, as it is not automatically provided.

The BID (Bulletin Identifier) is entered beginning with a US Dollar Sign (\$). The remainder of the BID is free-form and is filled according to local practice.

**Subject:** A maximum of 70 characters may be entered with a <CR>. If too long a subject is entered, the PMS will truncate the part exceeding 70 characters. Only 28 characters of the subject are displayed when the messages are listed, therefore users accessing the PMS will only see the first 28 characters of the subject until they read the message.

**Text:** End each line with a <CR>. End the message by typing <CR>, /ex, or CNTL-Z at the beginning of a new line.

Message size is limited only by the unused memory space available in the PMS message storage area. If that space is exceeded, the PMS will display:

**-Buffer overflow**

When the message has been saved, the PMS will display:

**Message saved as Msg#n**

**SENDPAC**      **n**      **Default: \$0D <CR>**

n = 0 - \$7F, specifying an ASCII character.

This command selects the ASCII code (parameter n) for the character that will force input to be packetized and queued for transmission in Converse Mode. You may enter the code in either hex or decimal.

For conversation, set SENDPAC = \$0D and CR ON. This causes packets to be sent at natural intervals, and causes the <CR> to be included in the packet. If CPACTIME is ON, set SENDPAC to some value not ordinarily used (i.e. <CNTL-A>), and set CR OFF. This allows forcing packets to be sent, but will not result in extra <CR> characters being transmitted in the text.

♦ **SILENT**      **ON|OFF or Yes|No**      **Default: OFF**

ON      - The packet controller does not output prompts or messages.

OFF      - The packet controller sends all sign-on messages and prompts.

This command disables all the initialization (sign-on) messages, error messages and prompts for applications which would be disturbed if the messages were sent.

This is useful when the packet controller is attached to a serial printer, data logger, or other device which expects to receive no control commands or informational messages and treats all output from the controller as 'user data.'

SILENT does not affect the echo function which must still be separately be controlled by the ECHO command.

**SLOTS**      **Discontinued Command**

The SLOTS command is no longer supported in PacComm firmware. The command may be present in some firmware versions, but is not operative.

**SLOTTIME**      **n**      **Default: 1**

n = 0 - 255, specifying 100ms increments.

SLOTTIME is part of the P-Persistence channel access technique selected by the PPERSIST command.

SLOTTIME selects the length of the delay between attempts to access the channel. Larger SLOTTIME values lower the packet controller's priority in accessing the channel.

• **SOFTDCD**      **ON|OFF or Yes|No**      **Default: See Below**

ON      - The DCD signal is derived from firmware

OFF      - The DCD obtained from the modem hardware.

This parameter should be set to ON when using a TNC-220 which is NOT equipped with a tuning indicator.

SOFTDCD MUST be set to OFF for proper operation of all models which do not use the 8530 SCC. Use of the SOFTDCD command is not recommended for any model except the TNC-220.

**SP**

This is an extension of the PMS SEND command. SP causes the message status to be marked with a P designator for personal or private. Refer to the SEND command for detailed instructions.

**SR**                      **n**

n = Number of PMS message which is replied to.

SR stands for Send Reply. The message number must be included. The SR command is not used to send a reply to the most recently read message. If no message number is included, the following message is displayed:

**parameters are missing**

SR automatically reverses the TO and FROM callsigns from message number n and enters the same subject in the reply message, preceded by "re:".

The proper entry is made in the @BBS field if this information can be determined from the received message. When the proper entry for the @BBS field can not be reliably determined, use the EDITHDR command to edit the @BBS callsign if one is needed.

In the example below, message 12 was generated by giving the command:

SR 11

```

Msg# Stat Date Time To From @BBS Subject
11 PR 05/28/97 10:04 N4UQR W4DPH @W4DPH Meeting
12 PR 05/28/97 12:49 W4DPH N4UQR @W4DPH Meeting
11206 Bytes free
Next message Number 13
    
```

**ST**

This is an extension of the PMS send command. ST causes the message status to be marked with a T designator for National Traffic System (NTS) traffic. The text of such a message should be filled with an NTS formatted message. Refer to the SEND command for detailed instructions.

**START**                      **n**                                      **Default: \$11 {CNTL-Q}**

n = 0 - \$7F, specifying an ASCII character code.

The START command selects the terminal Restart character, which is used by the terminal to restart the output from the TNC to the terminal after it has been halted by receipt of the terminal Stop character. The code may be entered in either hexadecimal or decimal.

If the terminal Restart (START) and terminal Stop (STOP) characters are set to \$00, software flow control to the packet controller is disabled, and the packet controller will only respond to hardware flow control.

If START and STOP are set to the same character, the packet controller will alternately start and stop data flow upon receipt of the character.

### STATUS

|      |  |
|------|--|
| \$00 | - Disconnected state.                                  |
| \$01 | - Connect in progress.                                 |
| \$03 | - Disconnect in progress.                              |
| \$04 | - A connection exists and all frames are acknowledged. |
| \$06 | - A connection exists and unacknowledged frames exist. |

STATUS is an immediate command which returns a hexadecimal value indicating selected link parameters on the current stream.

### STEXT                      text                                      Default: blank

|      |  |
|------|--|
| text | - a string of up to 80 characters ending with a carriage return. |
|------|--|

STEXT contains the text which is sent as the PMS custom sign-on message. If STEXT is blank, no message is sent. The default text is blank, i.e. no message. You can send multiple-line messages in the beacon by including carriage return <CR> characters in the text preceded by the PASS character.

If you enter a text string longer than 80 characters, an error message will appear and the command will be ignored.

LOGONMSG controls the standard sign-on message and is not related to STEXT.

### STOP                      n                                      Default: \$13 {CNTL-S}

|  |
|--|
| n = 0 - \$7F, specifying an ASCII character. |
|--|

The STOP command is used to set the value of the character used as the terminal Stop character. The terminal Stop character stops output from the packet controller to the terminal, i.e. halts scrolling. The code may be entered in either hexadecimal or decimal.

Output is restarted with the terminal Restart character, which is set by the START command. If the terminal Restart (START) and terminal Stop (STOP) characters are set to \$00, software flow control to the packet controller is disabled and the controller will only respond to hardware flow control. If START and STOP are set to the same character, the packet controller will alternately start and stop data flow upon receipt of the character.

**◆STREAMCA ON|OFF or Yes|No Default: OFF**

ON - callsign of other station is displayed.  
 OFF - callsign of other station is not displayed.

The STREAMCA command is used to enable the display of the connected-to station callsign after the stream identifier. This option is useful for operators attempting to operate multiple simultaneous connections. In the example below, the characters inserted by enabling STREAMCA are shown in bold type:

|                              |                           |
|------------------------------|---------------------------|
| <b>STREAMCA = ON</b>         | <b>STREAMCA = OFF</b>     |
| A:K4NTA:hi howie             | A hi howie                |
| hello ted how goes it?       | Hello ted how goes it?    |
| B:N7CL:*** CONNECTED to N7CL | B *** CONNECTED to N7CL   |
| A Ted, AZ on other stream    | A Ted, AZ on other stream |

What looked like “|B” appears as “|B:<callsign>:” with STREAMCA ON.

**◆STREMCALL ON|OFF or Yes|No Default: OFF**

An alternate spelling of STREAMCALL in some firmware versions.

See STREAMCA above.

**◆STREMX ON|OFF or Yes|No Default: OFF**

ON – Enable streamswitch character display at the start of each line.  
 OFF – Disable streamswitch character at the start of each line.

When STREMX is ON, each text line of a received packet will have the streamswitch character (|) and the letter denoting which stream is active.

With STREMX ON: |CThis is an example of STREMX ON.

With STREMX OFF: This is an example of STREMX OFF.

**STREAMDB ON|OFF or Yes|No Default: OFF**

ON - double all received STREAMSW characters.  
 OFF - do not double received STREAMSW characters.

This command is used to display received STREAMSW characters by “doubling” them. This is useful for distinguishing between STREAMSW characters received from other stations and those generated by the packet controller. With STREAMDB ON, and STREAMSWitch set to “|”, the following is an example of what may be displayed by your packet controller:

| | this is a test.

In this case the sending station actually transmitted:

| this is a test.

This same stream with STREAMDB OFF would appear as:

| this is a test.

**STREAMSW n Default: \$7C <I>**

n = 0 - \$FF, specifying an ASCII character.

This command selects the character to indicate a new stream is being addressed. Set it to a value seldom used in normal text. **NOTE:** The STREAMSW character **MUST NOT** be the letters A through Y.

The character can be PASSED in Converse Mode but flows through as data in Transparent Mode. Thus the outgoing stream cannot be changed while "on-line" in Transparent Mode. You must enter Command Mode to switch streams.

Also see the STREAMDB and STREAMCA commands.

**TKILLOK ON|OFF or Yes|No Default: OFF**

ON - traffic messages may be killed by anyone.

OFF - traffic messages follow normal rules.

The TKILLOK ON command allows any user on the radio port to kill an NTS (T) type of message in the PMS.

TKILLOK OFF requires the connected PMS user's callsign to match the message callsign before it will allow the message to be killed. This command does not affect the kill function on the terminal port.

**TPERSIST Discontinued Command**

The TPERSIST command is no longer supported in PacComm firmware. The command may be present in some firmware versions, but is not operative.

**TRACE ON|OFF or Yes|No Default: OFF**

ON - Trace mode is enabled.

OFF - Trace mode is disabled.

TRACE enables the protocol debugging function. TRACE ON displays all received frames in their entirety including all header information. A trace display will appear in four columns on an 80 column display.

**TRANSPARENT**

TRANSPARENT is an immediate command which causes the packet controller to enter Transparent conmode. The current link state is not affected.

Transparent Mode is primarily useful for computer communications. In this mode the "human interface" features such as input editing, echoing of input characters, and type-in flow control are disabled and all control characters are passed without action.

To exit the Transparent Mode, enter <CNTL-C> if the link state is disconnected, and three <CNTL-C>'s if the link state is connected.

**TRFLOW**      **ON|OFF or Yes|No**      **Default: OFF**

ON      - Transparent Mode terminal flow control can be enabled.  
 OFF      - Transparent Mode software flow control is disabled.

TRFLOW allows software flow control to be used in Transparent Mode on data *received* over the serial port from the terminal.

If TRFLOW is ON, and START and STOP are non-zero, Transparent Mode software flow control is enabled for the serial port. The packet controller will look for the START and STOP characters in the data stream and treat them as flow control commands. Thus truly transparent operation is not possible.

If TRFLOW is OFF, *or* START and STOP are set to \$00 (disabling response to the terminal's Stop and Start characters) hardware flow control must be used by the terminal and all characters received by the packet controller are transmitted as data resulting in completely transparent operation.

Unless TXFLOW is ON, only hardware flow control is available to the packet controller to control output from the terminal.

**TRIES**      **n**      **Default: none**

n = value to force tries counter to.

This command is used to retrieve the count of the "RETRIES" on the currently selected input stream. It is useful in obtaining statistics on the performance of a given path or channel.

If the packet controller has an outstanding, unacknowledged frame, TRIES will return the current number of tries (or attempts at delivery of the packet); if the packet controller has no outstanding, unacknowledged frames, it will return the number of tries that were required for the previous frame. If RETRY is set to zero (0), the value returned by issuing a TRIES command will always be zero.

If followed by an argument, TRIES will force the "TRIES" counter to the entered value. *This usage is NOT recommended.*

**◆ TRMAX**      **n**      **Default: 3**

n = 0-255 specifying the number of seconds to wait for channel allocation.

This command is part of the support for trunked radios. See TRUNK for a complete explanation..

In trunking systems where PTT is held on continuously until a channel is allocated, (which requires the command TRSTYLE = OFF) TRMAX sets the length of a timeout period for the PTT in case no channel allocation signal is received.

**◆ TRSENSE    ON|OFF or Yes|No                    Default: OFF**

ON     - Johnson/Uniden (active low)  
OFF    - Motorola (active high)

This command is part of the support for trunked radios. See TRUNK.

This command selects whether the channel allocation signal received via the RFDCCD input is to be active high or active low.

**◆ TRSTYLE    ON|OFF or Yes|No                    Default: ON**

ON     - PTT is off while waiting for channel allocation.  
OFF    - PTT is on continuously until a channel is allocated.

This command is part of the support for trunked radios. See TRUNK.

TRSTYLE selects the type of keying algorithm used when TRUNK is ON.

TRSTYLE OFF holds the PTT line active while the radio is undergoing channel allocation. If the channel allocation signal is not received before TRMAX expires, the keying line is released and the cycle is reinitiated.

TRSTYLE ON activates the PTT line to request a channel, then drops the PTT until a channel allocation signal is received.

**◆ TRUNK      ON|OFF or Yes|No                    Default: OFF**

ON     - Use the radio keying algorithm selected by TRSTYLE.  
OFF    - Use conventional PTT protocol.

This command activates special keying algorithms to support trunked radio systems (Specialized Mobile Radio – SMR). The TRSTYLE parameter determines which keying algorithm is enabled by TRUNK.

Set TRUNK OFF for conventional radios.

**TXDELAY      n    Default: 15**

n = 0 -120, specifying 10ms intervals.

This value tells the packet controller how long to wait after keying up the transmitter before sending data. Some startup time is required by all transmitters to put a signal on the air; some need more, some less.

The correct value for a particular rig should be determined by experimentation. The proper setting of this value may also be affected by the equipment of the station being communicating with. If loud, clear signals are not decoded, suspect the TXD of the transmitting station is set too low (or the station is overdeviating!)





**TXUIFRAM    ON|OFF or Yes|No                    Default: ON**

- |     |                                     |
|-----|-------------------------------------|
| ON  | - UI frames may be transmitted.     |
| OFF | - No UI frames will be transmitted. |

This command eliminates the dumping of unsent frames as UI (Unnumbered Information or Unprotocol) frames when a connection fails. It is useful to operators of Packet Bulletin Board Systems (BBS).

TXUIFRAM ON will also prevent sending UI frames from the keyboard in Converse Mode, but will not interfere with the sending of beacons.

**UIBEACON    ON|OFF or Yes|No                    Default: OFF**

- |     |   |
|-----|---|
| ON  | - The packet controller sends BTEXT in response to a UI poll. |
| OFF | - The controller does not respond to a UI poll.               |

When UIBEACON is ON, and a UI frame is received addressed to MYCALL, the BTEXT will be sent immediately and the beacon timer (if enabled) will be reset to the full beacon period.

**UILOC            ON|OFF or Yes|No                    Default: OFF**

- |     |   |
|-----|---|
| ON  | - The TNC sends the GPS capture buffers in response to a UI poll. |
| OFF | - The TNC does not send buffers in response to a UI poll.         |

When UILOC is ON and UIBEACON is ON, and a UI frame is received addressed to MYCALL, the GPS capture buffers (LTEXT etc.) will be sent immediately and the Location timer (if enabled) will be reset to the full location period.

**•UIMODE            ON|OFF or Yes|No                    Default: OFF**

- |     |  |
|-----|--|
| ON  | - The packet controller enters CONMODE on power up.      |
| OFF | - The packet controller enters Command Mode on power up. |

The UIMODE controls the initial state of the packet controller when power is first applied. When UIMODE is OFF, the packet controller initializes to the Command Mode and waits for a command from the asynchronous serial port.

When UIMODE is ON, the packet controller initializes into the CONMODE without any commands from the serial port. Any characters received from the serial port will be packetized and transmitted as UI frames.

In other words, the TNC will not come up with a CMD: prompt if UIMODE is ON, but will instead be in either CONVERS or TRANS mode as specified by CONMODE. The TNC will be ready to send UI frames generated by APRS or a telemetry source without any operator intervention or additional setup.

Note: The DATAMODE command replaces UIMODE in some models.

**•UIWIndow ON|OFF or Yes|No Default: OFF**

ON - The UIWINDOW function is enabled.  
OFF - The UIWINDOW function is disabled.

This command enables or disables the UIWINDOW function i.e. the WINOpen and WINClose commands.

UIWINDOW allows setting of time bands when location beacons will be sent. When UIWIndow is ON, location beacons will be sent at the rate specified by the LOC command beginning at the first time specified in WINOPEN and ceasing at the first time specified in WINCLOSE, beginning again at the second time in WINOPEN until the second time in WINCLOSE, etc.

For example if WINOPEN = 0730 1700 and WINCLOSE = 0830 1800 location beacons will be transmitted during daily commuting hours of 0730-0830 and 1700-1800.

**UNPROTO call#1[ Via call#2 [,call#3,...,call#9]] Default:CQ**

call#1 - Callsign to be placed in the TO address field.  
call#2-9 - Optional digipeater call list, up to eight calls.

This command sets the digipeat and destination address fields of packets sent in the unconnected (UNPROTOcol) mode.

Unconnected packets are sent as Unnumbered Information (UI) frames with the destination and digipeat fields taken from call#1 through call#9 options. The default destination for unconnected packets is CQ. Callsigns may be separated by either spaces or commas. See the CONNECT command for greater detail about entering a callsign and digipeater string.

It is not normally important what callsign is set into UNPROTO for UIMODE/DATAMODE communication. However see the commands DGPCALL, QRA, UIBEACON, UILOCATION which are dependent on the UNPROTO callsign.

**USERS n Default: 1**

n = 0 - 5, the total number of connections allowed.

USERS sets the maximum number of connections allowed. USERS affects only the manner in which incoming connect requests are handled, it has no effect on the number (or handling) of connections initiated by the packet controller. For example:

USERS 0 allows incoming connections on any free stream  
USERS 1 allows incoming connections on stream A only  
USERS 2 allows incoming connections on streams A & B

...  
USERS 5 allows incoming connection on streams A-E.

The number of possible streams varies among products.

**UTC**                    **ON/OFF or Yes/No**                    **Default: OFF**

The UTC command enables the TNC time of day clock to be updated with GPS UTC time in the HHMMSS fields. If FIXTYP is set to 5 for the \$GPRMC sentence then the date is also updated to the GPS UTC date.

The RTCSYNC command must be set to ON for UTC to take effect.

**VERSION**

The VERSION command causes the entire packet controller firmware sign-on banner to be displayed, including the features supported, firmware release number and date.

**◆WATCHDOG**                    **n**                    **Default: 0**

n = 0-65536 specifying the number of seconds between automatic restarts.

If no station has connected for n seconds, the packet modem will initiate a RESTART command using the parameters saved in RAM. If n = 0 the function is disabled.

This command is useful for packet modems installed at limited access sites and when using remote commanding. If the packet modem fails to accept a connection for n seconds, it will restart itself. This may overcome difficulties experienced as a result of power supply transients, RF fields, or inappropriate remote commands.

**◆WINOPEN**                    **text**                    **Default: blank**

WINOPEN works with the command UIWINDOW.

WINOPEN text is one or more times expressed in 24hour format which denote the beginning times for actuation of LOCATION beacons controlled by the UIWINDOW command. Times should be separated by a single space. For example: 1030 1200 1400 1700.

**◆WINCLOSE**                    **text**                    **Default: blank**

WINCLOSE works with the command UIWINDOW.

WINCLOSE text is one or more times expressed in 24hour format which denote the ending times for actuation of LOCATION beacons controlled by the UIWINDOW command. Times should be separated by a single space. For example: 1040 1210 1430 1900.

**XFLOW**      **ON|OFF or Yes|No**      **Default: ON**

|     |  |
|-----|--|
| ON  | - XON/XOFF (software) flow control is enabled. |
| OFF | - XON/XOFF flow control is disabled.           |

If XFLOW is ON, the computer or terminal is presumed to respond to the packet controller START and STOP characters, set by XON and XOFF.

If XFLOW is OFF, the packet controller will communicate flow control commands via RTS.

**XMITOK**      **ON|OFF or Yes|No**      **Default: ON**

|     |                                    |
|-----|------------------------------------|
| ON  | - Transmit functions are enabled.  |
| OFF | - Transmit functions are disabled. |

When XMITOK is OFF, transmitting is inhibited. All other functions of the packet controller remain the same, i.e. the packet controller generates and sends modulated audio to the radio, but does not key the radio PTT line.

This command is useful for safety purposes. It ensures that the packet controller does not transmit during the adjustment of radio equipment, but allows the controller to continue to monitor the channel.

**XOFF**      **n**      **Default: \$13 [CNTL-S]**

|   |
|---|
| n = 0 - \$7F, specifying an ASCII code character. |
|---|

This command selects the TNC STOP character (hexadecimal or decimal), which is set from the packet controller to the computer to stop input from that device.

This character would normally be set to <CNTL-S> for computer data transfers. If you want notification when the buffers are filled in Converse Mode, set this character to <CNTL-G> (\$07), which rings the terminal bell.

See also XFLOW.

**XON**      **n**      **Default: \$11 [CNTL-Q]**

|   |
|---|
| n = 0 - \$7F, specifying an ASCII code character. |
|---|

This command selects the TNC START character (hexadecimal or decimal), which is set from the packet controller to the computer to stop input from that device.

This character would normally be set to <CNTL-Q> for computer data transfers. If you want notification when the buffers are filled in Converse Mode, set this character to <CNTL-G> (\$07), which rings the terminal bell.

See also XFLOW.

## Packet Controller Messages

This sign-on message appears when the packet controller is powered on or the RESET command is issued. The release number indicates the software version. FEATURES: is followed by a list of optional firmware features in the EPROM.

```
| A
PacComm [model] packet controller
(c) Copyright 1985-2000 PacComm

AX.25 Level 2 Version 2.0
Features:
Release n.n.n Month Day, Year
(Optional custom message line here)
cmd:
```

**NOTE:** The |A may display as a vertical-bar and any capital letter from "A" through "Y".

### bbRAM loaded with defaults

This message appears along with the sign-on message above if the battery backed-up RAM checksum verification fails at power-on time, causing the packet controller to load the default parameters from ROM. This message also appears if the packet controller loads the defaults in response to the RESET command.

### cmd:

This is the Command Mode prompt. When this prompt appears, the packet controller is waiting for you to issue a command. Anything you type after this prompt will be interpreted as a command. The prompt may have scrolled off the screen and not be visible, even though you are in Command Mode. You can type the redisplay-line character (set by REDISPLAY) or press the enter key to retype the prompt.

### was

Whenever you change the setting of one of the packet controller parameters, the previous value will be displayed. This confirms that the packet controller properly interpreted your command, and reminds you of what you have done.

### too many packets outstanding

If you have previously entered packet data filling the outgoing buffer in Converse Mode or Transparent Mode and then returned to Command Mode,

you will receive this message if you attempt to enter one of these data transfer modes before some of the packets have been successfully transmitted.

### **Command Mode Error Messages**

When a mistaken command is given to the packet controller, one of the following messages may be displayed.

#### **? parameter**

The command was typed correctly, but the remainder of the line couldn't be interpreted.

#### **? call**

The callsign argument does not meet the packet controller requirements for callsigns. A callsign may be any string of numbers and letters, including at least one letter. Punctuation and spaces are not allowed. The sub-station ID, if given, must be a (decimal) number from 0 to 15, separated from the call by a hyphen.

#### **? clock not set**

The command DAYTIME was given to display the date and time but the clock is not set. DAYTIME sets the clock if used with the daytime parameters, and displays the date and time if used alone.

#### **? unknown command**

The first word typed is not a command or a command abbreviation.

#### **? not enough**

Not enough arguments (parameters) for the command given.

#### **? range**

A numeric argument for a command was too large.

#### **? too long**

Too long a command line was entered, and was ignored. This might happen when you exceed the maximum number of allowed characters in a text field. If this error appears, the previous value of the text field has not been changed.

#### **?too many**

You gave too many arguments (parameters) for a command.

### **Link Status Messages**

The following messages give the status of AX.25 connections the packet controller is involved in. You may check the link status by giving the CONNECT command without parameters. If you do this when your packet

controller is not in the disconnected state, the packet controller will display the link status but will take no other action.

The packet controller will inform you whenever the link status changes. The link status may change in response to a command (CONNECT or DISCONNECT), a connect or disconnect request from another station, a disconnect due to the retry count being exceeded, an automatic time-out disconnect (CHECK), or a protocol error.

**?VIA**

This message appears if you attempt to enter more than one callsign for the CONNECT or UNPROTO commands without the VIA keyword.

**? not while connected**

An attempt to change MYCALL, AX25L2V2 or PORT was made while in a connected or connecting state.

**? not while disconnected**

Attempting to perform an operation that can only be done while connected. This message may appear when issuing a RECONNECT or CONPERM command.

**? already connected to that station**

An attempt was made to connect to a station to which a connection exists or is being built. The multi-connect software will not permit you to connect to the same station on different streams.

**Link state is: CONNECTED to call#1 [VIA call#2 [,call#3...,call#9]]**

This display shows the station your packet controller is connected to and the digipeater route if any. The callsign sequence is the same sequence you would enter to initiate the connection.

**\*\*\* LINK OUT OF ORDER, possible data loss [optional daytime stamp]**

This message is issued upon failure of a CONPERMed link.

**Link state is: DISCONNECTED**

No connection currently exists. You may issue the CONNECT command to initiate a connection.

**Link state is: CONNECT in progress**

You have issued a connect request, but the acknowledgment from the other station has not been received. If you issue a DISCONNECT command, the connect process will be aborted.



**Link state is: DISCONNECT in progress**

A DISCONNECT command was issued, but the acknowledgment has not been received. Giving a second DISCONNECT command will cause the packet controller to go immediately to the disconnected state.

**Link state is: FRMR in progress**

The packet controller is connected but a protocol error has occurred. An improper implementation of the AX.25 protocol could cause this state to be entered. The packet controller will attempt to re-synchronize frame numbers with the TNC on the other end, although a disconnect may result. Connects are not legal in this state, and a disconnect will start the disconnect process.

**\*\*\* CONNECTED to: call#1 [VIA call#2 [,call#3...,call#9]]**

This message appears when the packet controller goes from the "disconnected" or "connect in progress" state to the connected state. The connection may be a result of a CONNECT command you issued, or of a connect request packet received from another station.

**\*\*\* connect request: call#1 [VIA call#2 [,call#3...,call#9]]**

This message indicates that the packet controller has received a connect request from another station which it has not accepted. This can happen if you have set CONOK OFF or if you are already connected to another station. When the packet controller types this message it also sends a DM packet (busy signal) to the station that initiated the connect request. If the packet controller rejects a connect request because you have set CONOK OFF, you can issue your own request to the station that called.

**\*\*\* DISCONNECTED**

This message is displayed whenever the packet controller goes to the disconnected state from any other link state. This message may be preceded by a message explaining the reason for the disconnect.

**\*\*\* retry count exceeded**

**\*\*\* DISCONNECTED**

This message is given if the disconnect was caused by a retry failure rather than by a disconnect request from one of the stations.

**\*\*\* callsign busy**

**\*\*\* DISCONNECTED**

This message indicates that your connect request was rejected by a DM packet (busy signal) from the other station. That might mean CONOK is OFF or the station is already connected to another station.

**FRMR frame just sent:**

**FRMR sent:string**

The packet controller is connected, and a protocol error has occurred. The packet controller has sent a special FRMR packet to attempt to re-synchronize frame numbers with the TNC on the other end. The string is replaced with the hex codes for the three bytes sent in the information part of the FRMR frame. This message will not appear if your packet controller is in Transparent mode.

**FRMR rcvd:**

This message is followed by a display of the FRMR packet received in the trace display format. (See the TRACE command.) This message will not appear if your packet controller is in Transparent Mode.

**PMS Response Messages**

---

This section describes messages generated by the Personal Message System (PMS). The term USER is applied to an over-the-air PMS user, and SYSOP to the packet operator.

**[PMS-3.2-CS]**

SIDstring sent by PMS during forwarding sessions to the HOMEBBS.

**\*\*\* CONNECTED TO (PMS callsign)**

**Logged on to (PMS callsign)'s Personal Message System**  
(optional message line copied from SText - may be blank)  
**CMD(B/H/J/K/KM/L/M/R/S/SR/V/?)>**

This text is sent when a user connects to the PMS. Either or both of the message lines may be displayed based on PMS parameter settings.

**\*\*\* PMS-callsign busy**

**\*\*\* DISCONNECTED**

If the Sysop is entering a message, or PMS is OFF, a user attempting to connect over the air will receive a 'busy' message.

**PMS IS BUSY**

This message is sent if the PMS is in use by an over-the-air user, and the system operator attempts to enter or kill a message or any other action which would alter the contents of the PMS memory area.

**MYPCALL's Personal Message System**

Sent to the connecting station if the PMS parameter LOGONMSG is ON.

**You have mail waiting.**

Sent to a user after PMS log on if mail is addressed TO that callsign.

The following display is sent in response to the Help or ? command from a PMS user.

|                  |  |
|------------------|--|
| <b>B(ye)</b>     | B [CR] disconnects you from PMS.   |
| <b>H(elp)</b>    | H [CR] or ? [CR] displays this help file.  |
| <b>J(log)</b>    | J[CR] displays a list of callsigns heard (optional date/time).   |
| <b>K(ill)</b>    | K n [CR] deletes message n (only to/from your callsign).   |
| <b>KM(ine)</b>   | KM [CR] deletes all READ messages addressed to your call.  |
| <b>L(ist)</b>    | L [CR] lists the 10 latest messages.   |
| <b>M(ine)</b>    | M [CR] lists the 10 latest messages to/from your callsign.   |
| <b>R(ead)</b>    | R n [CR] reads message number n.   |
| <b>S(end)</b>    | S (callsign) [CR] begins a message addressed to (callsign).<br>Subject: max 28 characters ending with [CR].<br>Text: End each line with <BS>[CR]<D>. End message by typing<br>/ex<br>[CR] or CTRL-Z [CR] at the beginning of a new line. |
| <b>SB</b>        | Send Bulletin  |
| <b>SP</b>        | Send message marked Personal   |
| <b>SR n</b>      | SR n [CR] Sends a reply to message n .   |
| <b>ST</b>        | Send message in NTS format.  |
| <b>V(ersion)</b> | V[CR] displays the software version of the PMS system.   |

**Message erased**

This message is sent or displayed in response to the Kill command which originates from either the Sysop or user.

**Message marked for forwarding**

Response to the Sysop command to mark a message for reverse forwarding.

**Message forwarding reset**

Response to the Sysop command to 'unforward' a message previously marked for forwarding.

**Message has been sent to the printer queue**

Response to the PPRint Sysop command to print a PMS message on the packet controller printer port.

**Message saved as Msg # n**

Response sent or displayed after the completion of 'Sending' a message by either the Sysop or user.

**nnnnn Bytes free, Next message Number n**

Displayed at the end of the LIST display.

**-Logged off**

**\*\*\* DISCONNECTED**

This message as a result of the BYE command being issued by a PMS user.

**PMS Error Messages**

---

**[PMS CMD ERR]**

This message is issued when a PMS user sends a command in an improper format, commonly using more than one character of the command name. Sysop command errors receive the normal ? unknown command response.

**Message not found**

This message is issued whenever a READ or KILL command is given with an invalid message number by either a user or Sysop.

**YOU CANNOT KILL THIS MESSAGE**

This message is issued when a user attempts to kill a message not to or from his callsign.

**YOU CANNOT READ THIS MESSAGE**

This message is issued when an attempt is made to read a message not addressed to or from the user's callsign, or ALL.

**No third party mail allowed**

When 3RDPARTY is OFF, this message is issued when a user attempts to send a message to other than the PMS (Sysop) callsign.

**- Buffer overflow**

This message is issued when the PMS memory capacity is exhausted and the message being sent has been truncated.

**Parameters are missing**

This message is issued when the EDITHDR command is used by the Sysop with improper parameters.

**You cannot forward a bulletin**

This message is issued when an attempt is made by the Sysop to mark a bulletin for forwarding.

**Entry too long, try again**

Displayed whenever too many characters are entered at a prompt i.e. too long a BID or Subject entry.

## **Packet Radio Tutorial**

---

---

This chapter shows commands and packet controller responses in boldface type. Commands are boldfaced the first time used in a section and in normal typeface thereafter. The short form of the command is underlined when in text, but not when used in example commands.

### **First Steps**

---

---

Connect the packet controller to the computer with a properly configured serial cable. Turn the computer on and start the terminal program. Follow the directions for the program you are using to set the computer's baud rate to the speed and settings for the terminal indicated on the Software Release Notes. See the Technical Reference Manual for details.

Turn on the packet controller. You should see the following display.

```
| A  
PacComm [model] Packet Controller  
(c) Copyright 1985-2000 PacComm
```

#### **AX.25 Level 2 Version 2.0**

##### **Features:**

```
Release n.n.n Month, Day, Year  
(Optional custom message line here)  
cmd:
```

The first five lines are the sign-on message, which you will normally see only when you power up the packet controller. The line following Features: will contain a list of optional firmware features included in this EPROM. See the Errata for values of n.n.n and the release date for your model of packet controller.

The Command Mode prompt, cmd: will appear when the packet controller is in Command Mode and is ready to accept commands. If you see nothing, switch off the packet controller for a few seconds, then on again. If you still see nothing, verify the wiring and restart the terminal program.

You may use either UPPER CASE (capital letters) or lower case (small letters) when you enter commands. The shortest acceptable form of each command will be shown underlined in Command List of this manual. You must finish each

command line with a <CR>, or carriage return character. This may not be mentioned again in the examples below. Before you type the final <CR> of the command, you can correct typing mistakes or cancel the line completely.

Whenever the packet controller accepts a command, which changes a value, it displays the previous value to remind you of what you have done, and show the value has been successfully changed. For example, if you type:

**cmd: XFLOW OFF**

you might see the display

**XFLOW was ON**

**cmd:**

If you type something the packet controller can't understand you will get the unrecognized command error message:

**?unknown command**

If you get a command name correctly, but the arguments are wrong, you will see the message:

**?parameter**

### **Beginning Packet Operation**

This section will guide you through the basics of packet radio operation with the packet controller. Packet radio has a great deal of power and flexibility, and this section only scratches the surface of the packet station's capabilities. However, it contains the basic information required to begin operation.

#### **Setup**

Type the text, "MYCALL XXXXXX" following the Command Mode prompt. Of course, you should substitute your station CALLSIGN for XXXXXX. Don't forget the <CR>at the end of the line.

**cmd:MYCALL XXXXXX**  
**was NOCALL**  
**cmd:**

Your callsign will be used by the packet controller as its' "address". The packet controller responds with the previous value of the MYCALL parameter, and gives a new Command Mode prompt. Now try typing just the command by itself:

**cmd:MYCALL**  
**MYCALL XXXXXX**

This verifies that the packet controller accepted your CALLSIGN. You can see the current value of most parameters by typing the command that sets the parameter followed by a <CR>.

Most commands can be abbreviated. The minimum abbreviation for each command is given in the Commands chapter in this manual. Full length command names are used in this chapter for clarity.

### **Connected Mode vs. Connectionless Mode**

Packet communication may be conducted using a 'connection' or in a 'connectionless' mode. Both may be used simultaneously, if desired.

A connection is sometimes called a virtual circuit. It is analogous to dialing a telephone number on the public switched telephone system. Once established, all outgoing information from each station is automatically routed to the station at the 'other end' of the connection. By its nature, a connection is a one-on-one mode between two packet stations. In connected mode, data packets are tracked, correct reception is confirmed and lost or corrupted data is resent until received correctly.

Connectionless mode, also called broadcast or UI mode (for Unnumbered Information frame) allows simultaneous communication from one station to many other stations. The receiving station is able to determine if a corrupted frame is received (and discards it) but is not able to determine if a frame was missed entirely. There is no mechanism in the packet controller for retransmitting a lost or corrupted frame using this mode.

### **Establishing a Packet Connection**

Although there are still a number of features you should be familiar with for comfortable packet operation, you are probably eager to try out the packet controller. Have another packet operator help you get started. Make sure that he will be close enough to ensure solid signals, with no FM "popcorn" noise. Try to have both stations in the same room and operate on low power or into dummy loads.

Turn on the computer and the packet controller. Be sure you have adjusted the packet controller and radio according to the methods described in Technical Reference Manual. When the other station transmits, the DCD LED on the packet controller should glow steadily for the duration of the transmission. You can work through the remainder of the examples in this chapter while you try out the packet controller on the air. Remember to set the radio squelch control so no noise is being heard from the radio except during packet transmissions.

Packet radio connections are started by a connect process, which sets up the "handshaking" between the two stations that insures error-free

communications. Connections are terminated by a disconnect process, which leaves both stations free to start new connections.

### Starting the Connection

You are ready to initiate a connection using the **CONNECT** command. For the example, we will use **K5OXE** in place of your call sign, and we will use **K4GFG** for the other station's call.

Ensure you are in Command Mode, and type:

```
cmd:CONNECT K4GFG
```

After a moment you should see the message:

```
*** CONNECTED to K4GFG
```

and you will be in Converse Mode. The other station will see:

```
*** CONNECTED to K5OXE
```

and he will also be in Converse Mode.

If you monitor the radio transmit indicators and listen to the speaker audio from the two radios, you will have a better idea of what is happening. The radio will be inactive most of the time, even while you are actually typing. When you get to the end of a line and type a <CR>, the radio will be keyed briefly and the other station will hear the "brrrraaaap" sound on his speaker. As the message is displayed on his computer screen, his radio will be keyed for an even shorter time and you will hear a "brrraap" on the speaker.

This is the ACK, or packet acknowledgment coming back. The packet controller takes note that the packet was received correctly, but nothing is displayed.

In the example above, the packet controller entered Converse Mode automatically after the connection took place. To return to Command Mode, you must enter a special character, **Control-C** (abbreviated <CTRL-C>), or else send a **BREAK** signal. "Control" characters are usually entered by holding down the Ctrl key and then typing another key without releasing the Ctrl key.

If the keyboard doesn't have a key marked **CNTL** or something similar, consult the documentation for the computer or terminal program to see how to enter control characters. A **BREAK** signal is a special transmission (not an ASCII character) which the computer may be able to produce.



**NOTE:** If <CTRL-C> causes the computer to do something unwanted, such as halting the terminal program, and you can't send a BREAK signal, you will have to change the Command Mode character. See "Special Input Characters" below.

Now type a <CTRL-C>. The packet controller doesn't echo the <CTRL-C>, but you should immediately see a Command Mode prompt. To terminate the connection, you must type the DISCONNECT command. The packet controller will transmit packets terminating the conversation and notify you when the disconnect is complete:

```
cmd: DISCONNECT
*** DISCONNECTED
```

An actual connection might be ended by the other station. You would see the \*\*\* DISCONNECTED message without issuing the disconnect command.

### In Case of Difficulty

If there is difficulty getting a connection established, make sure the microphone drive level is set properly. It may be helpful to have an experienced packet operator listen to the signal. You can also try the following procedure.

Both stations should set MONITOR ON, then enter Converse Mode and send some packets. Each station should display the packets sent by the other. If only one station is "hearing" properly, you can concentrate on the modulator and transmitter of that station and the demodulator and receiver of the other station. You can try experimenting with the TXDELAY timing parameter for the sending packet controller. Set TXDELAY 64 for a long delay. If this solves the problem, try shorter and shorter delays and use the smallest value that works consistently.

### Digital Repeating (Digipeating)

You may wish to have a connection with another packet station that is beyond direct radio range. If a third packet station is on the air, that station can relay your packets. You set up the packet routing when you initiate the connection. Your packet controller will then automatically include the routing information in the packets it sends. The diagram below shows a situation in which digipeating is useful.

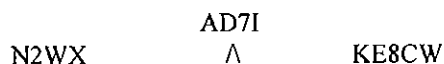

You are station N2WX, and you want to have a packet connection with KE8CW, who is not in direct range. However there is a station AD7I, which is

in range of both you and KE8CW. You direct the packet controller to set up a connection to KE8CW using AD7I as a digipeater as follows:

**cmd:CONNECT KE8CW VIA AD7I**

You can specify a routing list of up to eight intermediate stations. For example, consider a modification of the example above:

N2WX  $\frac{\quad}{\text{K4NTA}}$   $\wedge$   $\frac{\quad}{\text{W2VY}}$  KE8CW<R>

You can contact KE8CW by going through K4NTA and W2VY. This time you issue the connect command like this:

**cmd:CONNECT KE8CW VIA K4NTA, W2VY**

You specify the digipeaters in the order you would encounter them going from your station to the station to which you wish to connect.

Your station can also act as a digipeater for other stations. This doesn't require any special actions on your part. Digipeating may be disabled by the DIGIPEAT OFF command.

The commands **MYALIAS**, **MY1ALIAS**, **MY2ALIAS**, and **MY3ALIAS** will allow setting of alternate callsigns for digipeater identification in your packet controller. When an alias callsign is set, the controller will digipeat frames addressed to either **MYCALL** or **MYALIAS** callsigns, but will accept connections only to **MYCALL**.

Now that you are on the air, you can try out the packet controller's digipeating capabilities. This is more realistic if you have at least three stations participating, but you can get the feel for it with two stations.

Return to Command Mode and **DISCONNECT** from the other station and issue a new connect command:

<CNTRL-C>

**cmd:DISCONNECT**

**\*\*\* DISCONNECTED**

**cmd:CONNECT KP4DJT VIA KO4KS**

(Remember to use actual callsigns, not the ones in the examples). You are initiating a connection to your own packet controller. You transmit packets to the other station's packet controller, which relays (repeats) them back to your controller. When the connection is established you see

**\*\*\* CONNECTED to KP4DJT VIA KO4KS**

and you will be in Converse Mode. Monitor the radio transmit indicators and listen to the speaker audio. See if you can follow the packets and the acknowledgments back and forth. The other operator won't see anything displayed on his computer and his packet controller's state won't be affected at all by your connection. In fact, the other station could carry on a separate conversation completely independently.

**Unsuccessful Connections**

You may initiate a connect sequence that can't be completed. The station may not be on the air, or it may not be within range of your station. You may have even mis-typed the other call sign. If the packet controller does not get a response to its first connect packet, it will try again. You can control the number of attempts the packet controller will make with the command **RETRY**. The default number of retry attempts is 10. If the packet controller doesn't get an answer after this number of transmissions, it will give up and display the message:

**\*\*\* retry count exceeded**  
**\*\*\* DISCONNECTED**

The retry count is also used once the connection has started. Each transmission sent to the other station "acknowledged", or ACKed by the other station, and vice versa. The ACK means that the packet was received and that the CRC checksum indicated that it was received without errors. This is the means by which packet radio can ensure error-free communications. Sometimes a packet won't be received correctly by the other station, either because of accidental interference from another packet station (a collision), or because of other channel noise. If your packet controller doesn't get an ACK soon enough, it retransmits the packet and increments the retry count. If the count set by **RETRY** is exceeded, the packet controller will automatically disconnect and send the message shown above.

The number of tries may be determined at any time by entering the command **TRIES**.

The automatic disconnect feature keeps a packet controller from indefinitely re-transmitting a packet and tying up the channel under hopeless conditions. If you are operating under special conditions you can set **RETRY 0** to disable automatic disconnects (the retry limit is never reached).

If unacknowledged data packets existed at the time of the disconnection, the packet controller will send all of these data packets as Unnumbered Information

(UI) frames. To prevent the dumping of these frames over the air, set the command **TXUIFRAM OFF**.

If you have a connection established but wish to change the path being used (the sequence of stations listed after the VIA in the connect command) use the **RECONNECT** command. This command is used *while already connected*. For example, if a connection exists to W2VY via N2DSY and you wish to change the path to be W2VY via KD6TH, N2DSY, issue the command

**cmd:RECONNECT W2VY via KD6TH, N2DSY**

### Monitoring Channel Activity

Monitoring packet activity on the channel is enabled or disabled by the **MONITOR** command.

**cmd:MONITOR 2**  
**cmd: MONITOR was 1**

If you also want to see any intermediate digipeater stations being used, you can set **MRPT ON**. This feature would be useful if you later want to connect to one of the stations you are monitoring and will need a digipeater route in order to reach it. For example:

**KF4EF>KF4LG,W4ORA:Hello, Bill!**

This packet was sent from KF4EF via W4ORA to KF4LG.

If there are several digipeaters, or if the message lines are long, the display may be difficult to read. You can put the address header on a separate line from the text by setting **HEADERLINE ON**:

**KF4EF>KF4LG,W4ORA: Hello, Bill!**

Ordinarily, the packet controller will stop displaying monitored packets if you connect to another station, permitting you to converse without interruption. If you want to monitor activity while connected to a packet station, set **MCON ON**.

If you want to monitor without the display of any callsigns, set **ADDRDISP OFF**. This would cause the last example above to be displayed as:

**Hello Bill!**

The **ADDRDISP** command is mainly useful to monitor the packets from a single station. Use the commands **LCALLS** and **BUDLIST** to limit monitored packets to those of one station. If monitored frames seem to be double-spaced when using **ADDRDISP**, set **CRAFTER OFF**.

To display a list of stations heard since the last time the packet controller was powered up, type the command **MHEARD**. The last eighteen packet stations heard by the packet controller are displayed. The entry "K4NTA\*" means that K4NTA was heard via a digipeater rather than directly.

If the time-of-day clock is set, the date and time each station was most recently heard will also be displayed.

The Heard Log format includes the type of station heard. If the received frames can be identified properly, the term **NODE**, **BBS**, or **PMS** will be added to the Heard Log entry following the callsign.

Nodes are identified by the transmission of a level 3 type of frame. **BBS** and **PMS** stations are identified by an identification field of the format [XXX-xxxx], e.g. [PMS-3.2-C\$]. Some **BBS** programs do not conform to this format and will not be identified in the Heard Log. Nodes may be misidentified when handling **BBS** or **PMS** messages.

**cmd:MHEARD**

|                 |             |                 |                 |
|-----------------|-------------|-----------------|-----------------|
| <b>W4DPH-15</b> | <b>BBS</b>  | <b>04/30/97</b> | <b>17:31:12</b> |
| <b>K0ZXF</b>    | <b>BBS</b>  | <b>04/30/97</b> | <b>17:31:11</b> |
| <b>W8DUV*</b>   | <b>BBS</b>  | <b>04/30/97</b> | <b>17:26:14</b> |
| <b>CLW5</b>     | <b>NODE</b> | <b>04/30/97</b> | <b>16:55:00</b> |
| <b>W4MUA-1</b>  |             | <b>04/30/97</b> | <b>16:46:23</b> |

You can clear the "heard log" with the command **MHCLEAR**.

You can see the settings of the monitor parameters described above by typing **DISPLAY MONITOR**.

### Special Characters

The packet controller recognizes a number of special characters for input editing, flow control, and other control functions. You may change any of these special characters. Most of the characters are set by commands which specify the ASCII character code for the desired character. You can disable any special character feature by setting the character value to 0. Input editing characters may be disabled with no serious effects. You should use caution in disabling

the flow-control or Command Mode entry characters. Also be careful not to set two special characters to the same value.

Special characters are normally set to various control characters. Control characters are entered by holding down the control key while pressing the other key. For example, control-C, or <CTRL-C> is entered by holding down the control key while pressing C. If your computer doesn't have a control key you will have to consult the computer's documentation to see how to enter these characters. If you have difficulty entering control characters, you can change the special characters to, for example, seldom used punctuation.

ASCII Codes for Control Characters

| <i>Decimal</i> | <i>Hexadecimal</i> | <i>Control</i> | <i>Mnemonic</i> |
|----------------|--------------------|----------------|-----------------|
| 0              | S00                | <CNTL-@>       | NUL             |
| 1              | S01                | <CNTL-A>       | SOH             |
| 2              | S02                | <CNTL-B>       | STX             |
| 3              | S03                | <CNTL-C>       | ETX             |
| 4              | S04                | <CNTL-D>       | EOT             |
| 5              | S05                | <CNTL-E>       | ENQ             |
| 6              | S06                | <CNTL-F>       | ACK             |
| 7              | S07                | <CNTL-G>       | BEL             |
| 8              | S08                | <CNTL-H>       | BS              |
| 9              | S09                | <CNTL-I>       | HT              |
| 10             | S0A                | <CNTL-J>       | LF              |
| 11             | S0B                | <CNTL-K>       | VT              |
| 12             | S0C                | <CNTL-L>       | FF              |
| 13             | S0D                | <CNTL-M>       | CR              |
| 14             | S0E                | <CNTL-N>       | SO              |
| 15             | S0F                | <CNTL-O>       | SI              |
| 16             | S10                | <CNTL-P>       | DLE             |
| 17             | S11                | <CNTL-Q>       | DC1             |
| 18             | S12                | <CNTL-R>       | DC2             |
| 19             | S13                | <CNTL-S>       | DC3             |
| 20             | S14                | <CNTL-T>       | DC4             |
| 21             | S15                | <CNTL-U>       | NAK             |
| 22             | S16                | <CNTL-V>       | SYN             |
| 23             | S17                | <CNTL-W>       | ETB             |
| 24             | S18                | <CNTL-X>       | CAN             |
| 25             | S19                | <CNTL-Y>       | EM              |
| 26             | S1A                | <CNTL-Z>       | SUB             |
| 27             | S1B                | <CNTL-]>       | ESC             |
| 28             | S1C                | <CNTL-^>       | FS              |
| 29             | S1D                | <CNTL-_ >      | GS              |
| 30             | S1E                | <CNTL-^>       | RS              |
| 31             | S1F                | <CNTL->        | US              |
| 127            | S7F                | <DELETE>       | DEL             |

The action of each special character is described in detail under the entry in the Commands and Messages Section for the command that sets that character.

You can enter the code for a character in either hexadecimal (HEX, base 16) or decimal notation. The packet controller displays character codes in hex. A number of hex notation is indicated by beginning the number with a "\$" symbol. The "digits" of a hex number represent multiples of the powers of 16. The values 10 through 15 are represented by the letters A through F, which may be upper or lower case. For example: \$1B = 1 x 16 + 11 = 27. A table of ASCII codes for control characters appears above.

### Special Input Characters

The character used to return to Command Mode from Converse Mode is by default a <CTRL-C>. (Sending a BREAK signal also works). This character does nothing in Command Mode, so if you accidentally enter it twice you won't mess up the next command line. You can change the Command Mode character with the command **COMMAND**. You can choose any character for this function, by entering the ASCII character code for the key. For example, you can use a <CTRL-E> to enter Command Mode by setting

```
cmd:COMMAND 5
was $03
```

The packet controller displays the previous value in hexadecimal notation (hex). All of the special characters described below can be changed in the same way as **COMMAND**. If you set **DELETE ON**, you can erase characters by typing the <DELETE> character; setting **DELETE OFF** returns to using <BACKSPACE>. <BACKSPACE> is more commonly used than <DELETE> by personal computers. If you aren't sure whether the rubout key produces <DELETE> or <BACKSPACE> characters, try both settings and see which works.

When you rub out a mis-typed character, the packet controller will attempt to correct the screen display. If the display doesn't look right after you rub out a character, try setting **BKONDEL OFF**. The packet controller will not try to correct the display but will indicate the rubout with a "\ " character (<BACKSLASH>). You can restore display correction by setting **BKONDEL ON**.

If you want to cancel a whole line rather than rubbing out the characters one at a time, type <CNTRL-X>. The controller will display a <BACKSLASH> followed by <CR> and (in Command Mode) a new prompt:

```
cmd:Hi John, how ar<CNTRL-X> \      [You started typing text while in
cmd:                                Command Mode.]
```

The cancel-line character can be changed to any ASCII character by the command **CANLINE**.

If you have changed the input by rubbing out and retyping characters, you may want to see a "fresh" copy of the input, especially if BKONDEL is set to OFF. Type <CNTL-R> to have the controller retype the line you are entering.

```
cmd:CONNECT KB7\WA7<CTRL-R>\ [Call sign mis-typed.]
cmd:CONNECT WA7
```

Here the user mis-typed the first three characters of the call sign and rubbed them out. The packet controller displayed "V" for each character rubbed out. The user then retyped the characters correctly and redisplayed the line. He finished typing the call sign on the new line. The redisplay-line character can be changed to any ASCII character by the command REDISPLAY.

If the packet controller displays information faster than you can read it before it scrolls off the screen, you may halt the display by typing <CNTL-S>. To resume, enter <CNTL-Q>. These characters can be changed to any ASCII character by the commands STOP and START.

You can include any character or special character in a packet by prefixing it with the pass character, <CTRL-V>. For example:

```
I wasn't at the meeting.<CNTL-V><CR>
What happened?
```

Ordinarily, this message would be sent as two packets. By prefixing the first <CR> with <CTRL-V>, it is sent all at once, but maintains the <CR> in the text. The pass character can be changed to any ASCII character by the command PASS.

## Operating Modes

The packet controller has five operating modes. Command Mode and Converse Mode were previously mentioned. Transparent Mode, is a data-transfer mode like Converse Mode but is intended primarily for computer data interchange rather than conversation. The KISS data-transfer mode is a specialized data-transfer mode for use for packet satellite access and with the TCP/IP protocol. The GPS mode is a specialized mode for use with a Global Positioning System receiver.

**NOTE:** Some PacComm packet controllers have a sixth operating mode, the WA8DED Host Mode. A push button switch on the rear panel of the packet controller, if installed, selects this mode. The WA8DED Host Mode is described in an appendix to this manual.



### Command Mode

Command Mode is used to enter commands, which alter the packet controller's operating parameters. The other modes are entered from Command Mode. When the packet controller is in Command Mode, the Command Mode prompt, "cmd:" is printed at the beginning of each input line. Note that if the packet controller has received and displayed packets, the prompt may have scrolled off the screen.

The packet controller will be in Command Mode when power is turned on. (Exception: See the UIMODE command). After a power-off, power-on sequence, RESTART command all operating parameters of the packet controller are re-initialized to the parameter stored in battery backed-up RAM (bbRAM). After the RESET is issued all operating parameters are reset to the default values stored in EPROM. The packet controller will automatically reload the bbRAM from EPROM at power up if it finds that the data is bad.

The following commands set special characters, which are active in Command Mode.

| Command     | Description                                 |
|-------------|---|
| CANLINE     | Cancel current line                         |
| CANPAC      | Cancel output (Command Mode only)           |
| DELETE      | Character deletion                          |
| PASS        | Insert following special character          |
| REDISPLAY   | Re-display current line                     |
| START, STOP | User's flow control (sent from computer)    |
| XOFF, XON   | Packet unit flow control (sent to computer) |

The following commands enable display features that are active in Command Mode.

| Command  | Description                            |
|----------|--|
| AUTOLF   | Add <LF> after <CR> (data to terminal) |
| BKONDEL  | Echo after character deletion          |
| ECHO     | Automatic echo of serial port input    |
| FLOW     | Type-in flow control                   |
| FSCREEN  | Formatting of DISPLAY command output   |
| LCOK     | Lower case translation                 |
| LFIGNORE | Line Feed characters are ignored       |
| NUCR     | Nulls after <CR>                       |
| NULF     | Nulls after <LF>                       |
| NULLS    | Null count                             |
| SCREENLN | Automatic <CR> insertion               |

### Entering Data-Transfer Modes

There are several ways to enter a data-transfer mode from Command Mode.

You can type the command **CONVERSE** (or the single-letter command "K") to enter Converse Mode or the command **TRANSPARENT** to enter the Transparent Mode, and the packet controller will immediately enter the specified mode.

If the **UIMODE** (**DATAMODE** on some models) command is set to ON, the packet controller will enter **CONMODE** immediately at power-up, skipping Command Mode.

The packet controller will automatically enter a data-transfer mode when a connection is made. You specify the data-transfer mode for automatic entry with the command **CONMODE**.

**cmd:CONMODE Transparent**

**cmd:CONMODE Converse**

specify Transparent Mode and Converse Mode respectively.

The timing of the automatic entry into data-transfer mode depends on whether you or the other station initiated the connection. If you receive a connect request which your packet controller accepts, you will enter data-transfer mode when the packet controller sends the connect acknowledgment (ACK) and displays the message:

**\*\*\* CONNECTED TO <callsign>**

If you initiate the connection with the **CONNECT** command, you can control the timing of the mode change by using the commands **NEWMODE** or **NOMODE**. If **NOMODE** is OFF and **NEWMODE** is OFF, the mode will change when the connect ACK is received and the **\*\*\* CONNECTED TO: callsign** message is displayed. If **NOMODE** is OFF and **NEWMODE** is ON, you will enter data-transfer mode immediately, without waiting for a successful connection. Any text sent to the packet controller at this point will be queued up in packets that will wait for a successful connection before being sent. If the connect attempt fails, you will be returned to Command Mode. You will also be returned automatically to Command Mode when either station disconnects and ends the QSO.

If the command **NOMODE** is ON, no mode changes will be made automatically. This insures control by software in the host computer.

**Converse Mode**

The CONVERSE data mode used for ordinary keyboard conversation. In Converse Mode, the send-packet character causes the input to be packetized for transmission. If you type a full packet-length of characters without typing the send-packet character, your input will be packetized and transmitted anyway. The default send-packet character is <CR>, but you can specify any character with the command SENDPAC. You may choose to have the send-packet character transmitted in the packet. If the send-packet character is <CR> it is natural to include it in the packet as part of the text as well as interpreting it as a command. This is accomplished by setting CR ON. If you use another character to force packet transmission, you may set CR OFF and inhibit transmission of the send-packet character. If you set the send-packet character to something other than <CR>, you can cancel packets of more than one line with the cancel-packet character, which is set with the command CANPAC. Single-line packets can be canceled with either the cancel-line character or the cancel-packet character.

The following commands set special characters which are active in Converse Mode:

|             |   |
|-------------|---|
| CANLINE     | Cancel current line                         |
| CANPAC      | Cancel current packet                       |
| COMMAND     | Command Mode entry                          |
| DELETE      | Character deletion                          |
| MFILTER     | Monitored characters to be filtered         |
| PASS        | Insert following special character          |
| REDISPLA    | Re-display current line                     |
| SENDPAC     | Send current packet                         |
| START, STOP | User's flow control (sent to packet unit)   |
| XOFF, XON   | Packet unit flow control (sent to computer) |

The following commands enable display features that are active in Converse Mode:

|          |  |
|----------|--|
| 8BITCONV | Retain all serial port bits in Converse Mode |
| AUTOLF   | Add <LF> after <CR>                          |
| BKONDEL  | Echo after character deletion                |
| ECHO     | Automatic echo of serial input               |
| ESCAPE   | <ESCAPE> translation                         |
| FLOW     | Type-in flow control                         |
| LCOK     | Lower case translation                       |
| LFIGNORE | Line feed characters are ignored             |
| NUCR     | Null characters after <CR>                   |
| NULF     | Null characters after <LF>                   |
| NULLS    | Null count                                   |
| SCREENLN | Automatic <CR> insertion                     |

### **Transparent Mode**

Converse Mode will often work well for computer data transfer, but files such as a .EXE file on a MS/DOS system, a BASIC program, or even a word-processor text file, may contain characters which conflict with special characters in Converse Mode. If you transfer such files you will have to use Transparent Mode.

Transparent Mode recognizes no special characters; everything you type (or everything the computer sends to the packet controller) is sent over the radio exactly as the packet controller received it. There are no input editing features and there is no send-packet character. Packets are sent at regular time intervals or when a full packet of information is ready. The time interval at which data is packetized is set by **PACTIME**.

The display characteristics of the packet controller are also modified in Transparent Mode. Data is sent to the computer exactly as it is received over the radio, including all 8 bits of each byte received. Features such as auto-linefeed insertion and screen wrap are disabled, and echoing of input characters is disabled. The parameters that control these features in the Command Mode and the Converse Mode are not changed by entering the Transparent Mode, and all display features are re-enabled when the packet controller is returned to Command Mode. Most of the link status messages that appear as the packet controller moves between disconnected and connected states are also disabled in Transparent Mode.

In order to permit the Command Mode entry character to be transmitted freely in Transparent Mode, you utilize the Command Mode entry character in the following way: You must wait for a time period after typing the last character to be sent. This time is set by the command **CMDTIME**. Following this wait, you must type three Command Mode entry characters (default <CTRL-C>) within an interval **CMDTIME** of each other. After a final **CMDTIME** interval in which no characters are typed, you will see the "cmd:" prompt.

If any characters are typed during these **CMDTIME** intervals (even Command Mode entry characters) the escape will be aborted and all the Command Mode entry characters that have been typed will be sent as packet data. If you set **CMDTIME** to zero you will not be able to escape from Transparent Mode using this procedure.

You can also enter the Command Mode from the Transparent Mode by sending a **BREAK** signal. If the computer sending data to the packet controller can inadvertently send a data signal interpreted as a **BREAK**, set **BREAK OFF** to disable the packet controller's response to the signal.

### KISS Mode

The KISS mode is a simple data transfer mode controlled by the attached host computer. This is used when using Transmission Control Protocol/Internet Protocol (TCP/IP), or other communication software that interfaces with KISS, such as that used for accessing the MicroSat packet satellites. There is no value in entering the KISS mode unless such operation is contemplated.

There are two ways to enter the KISS mode. Enter the command;

**cmd:KISS ON**

followed by the command

**cmd:RESTART**

or use the immediate command

**cmd: MKISS**

The packet controller will stay in KISS mode despite use of the **RESET** command or turning the controller OFF. This 'permanent' activation of the KISS mode allows the user to access the KISS function reliably despite power outages or other problems. The battery backed RAM parameters for conventional packet operation are retained for later use.

To exit the KISS mode, the TCP/IP computer must issue the command **PARAM AX0 255**, or the packet controller must be given a hard reset by removing the backup power from the RAM, or you can do the following from an MS-DOS PC keyboard with most communication programs:

- 1) Hold down the ALT key,
- 2) Press keys 1, 9, and 2 on the numeric keypad,
- 3) Release the ALT key,
- 4) Hold down the ALT key again,
- 5) Press keys 2, 5, and 5 on the numeric keypad, and
- 6) Release the ALT key.

### GPS Mode

There is a set of commands designed especially to configure the packet controller to interface with an NMEA-0183 compatible Global Positioning System (GPS) or LORAN receiver for transmitting position information. The GPS mode is useful for tracking the location of a vehicle containing the packet controller and GPS receiver. The **GPSTEXT** command contains a user entered initialization string that is sent to the GPS receiver when the packet controller is powered on.

Note that one of two levels of GPS support may appear in a firmware release.

The standard level of support contains the commands:

GPS  
GPSEXIT  
GPSTEXT  
GPSTYPE  
LOCATION  
LPATH  
LTEXT  
UIMODE

The advanced (APRS) command set includes the above plus

EBEACON  
ELOCATION  
GPSLIMIT  
GPSSLEEP  
L1TEXT, L2TEXT, L3TEXT  
LGETCHAR  
LG1TEXT, LG2TEXT, LG3TEXT  
RTCSYNC  
UIBEACON  
UILOCATION

The **GPSTEXT** command contains the identifier of the NMEA-0183 GPS string which is to be transmitted. The default is \$GPGGA. To change the string to value \$XXXXXX, type the command

**cmd:GPSTEXT \$XXXXXX**

Any value may be entered in this field. There is no format checking. Each data string specified by GPSTEXT from a properly configured GPS receiver is automatically inserted into the Location Text (**LTEXT**), Connect Text (**CTEXT**), and PMS connect text (**STEXT**) fields.

Once all GPS commands are correctly set, type the command **GPS ON**. Then transfer the data cable from the computer terminal to the GPS output connector. *When in GPS mode, all normal TNC commands are inoperative.*

To escape from the GPS mode, the back slash “\” must be sent over the packet controller serial input port.

**LTEXT** is transmitted at the interval specified by **LOCATION** via the path contained in **LPATH**. The default path is to the GPS with no digipeater addresses set. Note that this path and the interval set by **LOCATION** are completely separate from the **UNPROTO** and **BEACON** commands that operate in a similar manner.

If **CMSGDISC** and **CMSG** are turned ON, a connection to **MYCALL** will result in the transmission of **CTEXT** (containing the latest position information) followed by an immediate disconnect. If **CMSGDISC** is OFF, (and **CMSG** is ON) then the **CTEXT** will be sent as the first data transmission after a connection is established.

Each connection to **MYCALL** (the PMS) will have the **STEXT** containing the latest position information sent as part of the PMS sign-on banner.

The **BEACON** command may also be used to periodically broadcast the station identification or other information without interfering with the position data transmissions.

The **UIMODE** (**DATAMODE**) command may be used if a continuous stream of GPS output is desired. Set **UIMODE** ON and leave **GPS** OFF. The packet controller will enter **CONMODE** immediately after power up and all characters output by the attached GPS will be transmitted via the path in **UNPROTO**.

## **Flow Control**

---

The packet controller's input buffer may fill up in Command Mode if you try to type too long a command. In Converse Mode the buffer may fill up because you are using a faster serial port baud rate than the radio data rate, or radio data transmission may have slowed down because of noise or other users on the channel, or the person or computer at the other end may have stopped output from that packet controller. The packet controller will signal the computer to stop sending data when there is room remaining for about 80 characters in the buffer. When the buffer fills up entirely, data will be lost. When the buffer empties so that there is room for at least 270 characters, the packet controller will signal the computer to start sending data again.

There are two methods of providing flow control which are supported by the packet controller. **XON/XOFF** flow control, sometimes called "software flow control," is accomplished by sending a special character (usually <CTRL-S>) to request that the output stop and another special character (usually <CTRL-Q>) to restart output. Hardware flow control may be used if both computers use the Clear To Send (CTS) and Request To Send (RTS) lines of the RS-232C standard.

Some commonly used terminal programs and file transfer programs for home computers do not implement flow control in software, and many serial ports do not support hardware flow control. Although the RTS and CTS lines appear at the connector, they may not be used unless the software reads the state of the CTS line. If you find that the packet controller seems to lose data during file transfers, you should immediately suspect a flow control problem.

### **XON/XOFF Flow Control**

If the computer or terminal does not support RTS/CTS flow control, you should use **XON/XOFF** flow control, which is enabled by setting **XFLOW ON**. The special flow control characters are set to <CTRL-S> and <CTRL-Q> by default. The commands **XON** and **XOFF** set the characters that will be sent to the terminal by the packet controller, and the commands **START** and **STOP** set the characters to be sent to the packet controller by the terminal. The computer may receive as many as 4 characters from the packet controller after sending a **STOP** character, since some characters may already be "enroute" through serial I/O chips.

If you send a **STOP** (or **START**) character to the packet controller when it is already stopped (or started), the character will be ignored. If the **STOP** and **START** character are the same character, this character will "toggle" the output, turning it off if it is on, and on if it is off.

You can disable **XON/XOFF** flow control in one direction only by setting the appropriate flow control characters to 0. If you do this, the packet controller will automatically use CTS flow control to stop input from the terminal. **XON/XOFF** flow control is normally disabled in Transparent Mode, since all characters are treated as data. If you cannot use RTS/CTS flow control, you may enable the **XON** and **XOFF** characters (the commands from the packet controller to the terminal) by setting **TXFLOW ON** and **XFLOW ON**.

The **START** and **STOP** characters (the commands to the packet controller from the terminal) can be enabled in the Transparent Mode by setting **TRFLOW ON**, however the mode will no longer be truly transparent.

### **Hardware Flow Control**

Hardware flow control is less likely to depend on the programming of a particular communications program. RTS and CTS are normally used for flow control signals in Transparent Mode. The command **XFLOW OFF** enables hardware flow control in Converse Mode and Command Mode. The computer may receive as many as 2 characters after it signals the packet controller to stop sending, since some characters may already be "enroute" through serial I/O chips. Refer to the Technical Reference Manual for details on the interface required for hardware flow control.



### **Type-in Flow Control**

Type-in flow control, enabled with the command **FLOW**, is really a display feature which keeps the packet controller from interrupting you with incoming packets. As soon as you type the first character of a line, the packet controller will put a "hold" on all output (except for echoing your input). The "hold" remains in effect until you type a <CR> to end the command line or a send-packet character to mark the end of a packet, or until you erase or re-display the line you have started. This is most helpful if you are not using a split screen communication program.

### **Station Identification**

Your station identification (callsign) is set with the **MYCALL** as previously described. If you have more than one station on the air operating with the same callsign, they must be distinguished --- no two stations can have identical station identifications, or the packet protocol will fail. You can distinguish additional stations by setting the "secondary station ID", or **SSID**. This is a number from 0 to 15, appended to the callsign with a dash:

**cmd:MYCALL K3AAX-3**

If you don't specify the **SSID** extension, it will be 0, however the packet controller won't explicitly display SSIDs that are 0. If you want to connect to a station with a SSID other than 0, or use such a station as a digipeater, you must specify the SSID:

**cmd:CONNECT N4KPU-2 VIA N7CL-5**

The packet controller can send an automatic identification packet every 9-1/2 minutes. You can enable this with the command **HID ON**. An ID packet is displayed as follows by a monitoring station:

**K4RHD-3>>ID:K4RHD/R**

You can request a final identification as you take your station off the air with the command **ID**. The packet controller will only send identification packets if it has been digipeating.

### **Automatic Operations**

Unattended (automatic) operation is legal in the USA on frequencies above 30 MHz. Check the latest FCC rulebook or the governing authority in your country.

### Unattended Connections

Your station will normally accept a connect request from another station if it isn't already connected or if multiple connections are enabled. You can disable this capability by setting **CONOK OFF**. If a connect request is received when **CONOK** is **OFF**, the packet controller will display the message:

\*\*\* connect request: <callsign>

and send a "busy signal" rejection packet to the other station. If you receive a rejection packet from a station you try to connect to, the packet controller will display

\*\*\* <callsign> busy  
\*\*\* **DISCONNECTED**

If you want to have a special 'connect message' sent automatically to stations connecting to you, you can specify the message with the command **CTEXT**. This message can consist of any text string up to 120 characters, and you may include <CR>'s by prefixing them with the pass character: (CTRL-V)

cmd:CTEXT Sorry, I can't talk right now. <CTRL-V><CR>  
I'll be on the air again after 8 P.M. Joe<CR>

In order for this message to be sent, **CONOK** must be **ON** so that the connection takes place (default) and **CMSG ON**. You can cause the packet controller to issue a disconnect request as soon as the connect message is acknowledged by issuing the command **CMSGDISC ON**.

**NOTE:** Turn **CMSGDISC** off when you resume in-person operation of the station to prevent premature disconnects.

If you want to leave the station on but inhibit transmitting, you can set **XMITOK OFF**. If you do this, you should set **CONOK OFF** as well.

### Beaconing

You can have the station periodically send an automatic message by enabling "beacons." The beacon message is set with the command **BTEXT**, which works the same way as the **CTEXT** command. You enable beacon transmission and set the frequency at which beacons are sent with the **BEACON** command. To transmit the beacon at 30-minute intervals, give the command

cmd:BEACON EVERY 180

The beacon function also has a transmit-after mode, enabled by using the keyword **AFTER** in place of **EVERY**, in which a beacon packet is only transmitted after activity is heard on the channel. This feature might be used to leave an announcement for other packet users. If someone transmits on an otherwise idle channel, a beacon can be sent a short time later. No beacons are sent in this mode if there is a lot of packet activity on the channel, since the required period of quiet will not occur.

**NOTE:** Use the Beacon feature with caution since much needless interference may be caused to other users of the channel by careless beaconing.

### **Connect Alarm**

The command **CBELL ON** will cause a 'bell' character (^G, \$07) to be sent to the terminal each time a connection is established.

### **Packet Formatting**

The maximum length of a packet is determined by the command **PACLEN**. If you type more than the maximum number of characters without entering a send-packet character, the packet controller will transmit a maximum-length packet. In the Transparent Mode, a packet will be sent if the maximum number of characters is entered before the delay conditions set by **PACTIME** force a packet to be sent. Older controllers may not accept packets longer than 128 characters.

If you have set the send-packet character to **<CR>**, you probably want the **<CR>** to be included in the packet for display at the other end. If you set the send-packet character to a special non-printing character, you probably want the character to be treated as a command only. The command **CR** controls whether the send-packet character is to be echoed and included in the packet.

You can add a **<LF>** after each **<CR>** included in your packets by setting **LFADD ON**. If the other station reports that lines are overprinted on his display, and he can't remedy the situation at his end, you can enable this function.

The packet controller implements AX.25 Level 2 Version 2 protocol, a set of rules for formatting messages to other packet controllers. This may be set to Version 1 with the command **AX25L2V2 OFF**. Digipeating may not be successful if some packet controllers are running Version 1.0 and some are running Version 2.0.

**NOTE:** Many operators prefer using Version 1.0 protocol, especially on marginal or noisy links in order to eliminate some of the overhead of AX.25 Level 2 Version 2.0 protocol.

You can specify the "address" to be used for unconnected packets, as well intermediate digipeaters with the **UNPROTO** command. The format is similar to that of the **CONNECT** command:

**cmd:UNPROTO QST Via WU4W**

The default address for unconnected packets is **CQ**.

The following functions may be helpful in tracking down protocol problems. They are seldom useful for ordinary packet operations. The error-checking function of the protocol is disabled for monitored packets with the command **PASSALL**. If you set **PASSALL ON**, any "packet" will be displayed if it meets the following conditions: It must start with a flag sequence; and it must contain an integral number of 8-bit bytes. The **TRACE** command enables the display of the address and control fields of packets, as well as the text. The trace function displays all bytes in hex as well as ASCII equivalents.

Following is an example of a compressed trace display. The frame shown in the example would be monitored as follows:

**KV7B>CQ,KF7B\*:this is a test message<D>**

| byte | hex display       | shifted ASCII   | ASCII        |
|------|-------------------|-----------------|--------------|
| 000: | 86A24040 40406096 | CQ 0KV7B 0KF    | @@`.n.@..    |
| 010: | 6E844040 E103F074 | 7B P.x:449.49.0 | n.@@ this is |

The byte column shows the offset into the packet of the beginning byte of the line. The hex display column shows the next 16 bytes of the packet, exactly as received, in standard hex format. The shifted ASCII column attempts to decode the high order seven bits of each byte as an ASCII character code. The ASCII column attempts to decode the low order seven bits of each byte as an ASCII character code. In a standard AX.25 packet, the callsign address field will be displayed correctly in the shifted ASCII column. A text message will be displayed correctly in the ASCII column. Non-printing characters and control characters are displayed in both ASCII fields as ".". You can examine the hex display field to see the sub-station ID byte and the protocol control bytes.

### Packet Transmit Timing

Radio equipment requires a time delay for switching between transmit and receive modes. If the packet controller starts sending data before the transmitter is operating or before the receiver has had time to switch from transmitting and lock up on the incoming signal, the packet will not be received properly. The delay between transmitter keyup and data transmission is controlled by the command **TXDELAY**. During the time the packet controller is keying the transmitter but not sending data, it will transmit a synchronizing signal (flags).

The command **TXDELAY** is used to fine-tune transmit delay after a transmit command is issued and before data is sent. The timing specified by **TXDELAYC** is calculated in character-times for the transmit speed in use. Used in conjunction with **TXDELAY**, it allows a link to be set for maximum performance. **TXDELAY** should be used to account for the time it takes the radio (the slower of this TNC's radio and the remote TNC's radio) to switch between receive and transmit and allow the receiving unit's data carrier detect (DCD) circuitry to respond. "0" bytes are sent to allow the remote TNC to synchronize to the data stream sent during **TXDELAY**. **TXDELAYC** then sends flags to start the frame. If **TXDELAYC = 0** is selected, the TNC will act as if **TXDELAYC 1** had been chosen.

With this method of transmit delay timing, a user may operate at various radio data rates without having to reset **TXDELAY** (if the same radios are used). The summation of **TXDELAY** and **TXDELAYC** will automatically adjust the keyup time for the varying rates.

If you are transmitting packets through a voice repeater, you may require a considerably greater key-up delay than is required for direct communications. Furthermore, the extra keyup delay is not required if the repeater has not had time to "drop" since the last transmission. The command **AXDELAY** allows you to specify an additional key-up delay to allow the repeater receiver and transmitter to lock up. The command **AXHANG** sets the time the packet controller will assume is required for the repeater to drop. If the packet controller has detected channel activity recently enough that the repeater transmitter should still be on, it will wait only the **TXDELAY** time before sending data, rather than adding an **AXDELAY** time as well. The commands **TXDELAY**, **AXDELAY**, and **AXHANG** all set times in units of 10 ms.

## **Alternate Transmit Timing**

### **P-Persistence Timing**

The P-Persistence method of timing may be enabled by the command **PPERSIST ON**. (This disables the retry timing using **FRACK**.) This timing method is most effective if all users on a channel use it.

**PPERSIST** uses the parameters **PERSIST** and **SLOTTIME**. When a frame is queued for transmission and the DCD is not active, a transmit/wait decision will be made based comparing a random number between 0 and 255 to the value of **PERSIST**. If the random number is less than the **PERSIST** value, the channel is seized. If not, then a delay of **SLOTTIME** is timed, and the random number/**PERSIST** calculation is repeated. Thus large values for **PERSIST** and small values for **SLOTTIME** produce the most aggressive channel access, and

small values for PERSIST and large values for SLOTTIME produce the most relaxed channel access.

### **Packet Retransmission Timing**

The AX.25 protocol provides for re-transmitting packets if no acknowledgment is heard from the intended destination station within a certain period of time. A packet might not be acknowledged due to channel noise or "collision" with another packet transmission, and since there may be other stations on the channel, the receiving station may not be able to acknowledge the received packet immediately. The time lapse before the originating station retransmits the packet is set by the command FRACK (frame acknowledge time). Do not set FRACK to a small value, as this will cause unnecessary retries, especially on HF.

The maximum number of retransmissions before the originating station terminates the connection is set by the command RETRY. The maximum number of transmissions of a packet is RETRY+1, since the initial transmission does not count as a retransmission. Setting RETRY to 0 specifies an infinite number of retries.

Acknowledgments of digipeated packets are made from end to end, and digipeaters do not acknowledge the packets they relay. If there are several intermediate relays, the chance of either the original packet or the acknowledgment to be lost increases drastically. An automatic wait time can be imposed on any station not transmitting a digipeated packet. This usually gives the digipeater a clear chance at the channel. The wait time is set by the command DWAIT, which specifies 40 ms intervals. If no digipeating is being done in the local area, this parameter can be set to 0, but in any event all members of a local packet group should set it to the same value.

In order to avoid unnecessary packet retries, the packet controller implements a collision-avoidance strategy which applies to all packets except those being digipeated. On the second and subsequent transmissions of a particular packet, the packet controller waits an additional random time after detecting a clear channel before beginning transmission. This prevents repeated collisions of transmissions by the same two stations. The random time is a multiple (0-15) of the TXDELAY time. The interval, in milliseconds, between the packet controller detecting carrier-drop and beginning to transmit is

- **Wait time = DWAIT \* 10**

for the first transmission of a packet. For subsequent transmissions of the same packet the interval is

- **Wait time = DWAIT \* 10 + ( r \* TXDELAY ) \* 10**

where *r* is a random number from 0 to 15. Thus, if the packet controller is forced to retransmit packets, you will occasionally hear a fairly long delay before transmission begins.

### **Acknowledgment Priority**

To reduce collisions on busy channels set the command **ACKPRIOR** to ON, which lets acknowledgment frames have priority. As the packet controller receives a frame that it must acknowledge (ACK), it will immediately send the ACK if the channel is clear. If other stations are running with **ACKPRIOR** ON, they will not access the channel until time has elapsed for transmission of the ACK, even if they cannot hear the station transmitting the ACK. When **ACKPRIOR** is OFF, acknowledgments are queued up for transmission the same as any other frame.

**ACKTIME** specifies the time required to send an acknowledgment to an I frame at the radio port data rate. This corresponds to about 510 mSec at 1200 bps with 8 digipeaters and about 140 mSec at 1200 bps with no digipeaters. The default of 140 mSec (**ACKT** 14) does not allow for any digipeaters in the path.

Multiple packets may be transmitted before waiting for an acknowledgment. This permits more efficient channel use when large amounts of data are being transferred. The maximum number of packets that the packet controller will send before waiting for acknowledgment is specified by the command **MAXFRAME**. **MAXFRAME** in combination with **PACLEN**, which sets the maximum number of characters in a packet, determines how much information can be sent in a single transmission.

### **Special Protocol Times**

You can set up a connection timeout with the command **CHECK**, which specifies a time in multiples of 10-second intervals. This function prevents the packet controller from getting stuck in a connection when the other station disappears for longer than the specified time.

The packet controller uses this time somewhat differently depending on the setting of **AX25L2V2**. For Version 2 (**AX25L2V2** ON), a Receive Ready (RR) frame is sent after no activity for **CHECK** time. If no response is received, the connection is disconnected; otherwise the **CHECK** timer is restarted.

If AX.25 Version 1 is being used, after **CHECK** time with no activity a disconnect frame will be sent without a previous status inquiry.

The command **CHECKV1** provides the same function for Version 1 as **CHECK** does for Version 2 even though the T3 timer is not defined for

Version 1. When **CHECKV1** is ON, the CHECK (T3) timer is used to automatically poll an AX.25 Level 2 Version 1.0 link when data hasn't flowed for CHECK time. When **CHECKV1** is OFF, T3 is ignored and normal Version 1.0 procedures apply.

The command **RESPTIME** sets a delay between the receipt of a packet and the transmission of the acknowledgment packet. This delay is used to prevent collision between an acknowledgment and another packet from the sending station. This is primarily necessary during file transfers; otherwise the delay is best set to 0 (default). During file transfers the receiving stations should set **RESPTIME** to 10 or 12.

The timing of packet transmission in Transparent Mode is determined by the command **PACTIME**. You can choose the way packet transmission is timed. If you are typing input to a remote computer it is usually best to have packets transmitted at regular intervals. If the computer is operating a remote host or bulletin board program you should send packets after an interval with no further input from the computer. You can enable the use of **PACTIME** in Converse Mode with the command **CPACTIME**.

### **Monitor Functions**

---

Monitoring of packets not addressed to your station is controlled by the **MONITOR** command. Separate monitor functions are individually enabled.

The command **MALL OFF** causes the packet controller monitor function to ignore connected packets.

To be able to monitor packet activity when your station is not connected, but have all monitoring automatically cease when you connect to someone, set **MCON OFF**.

To monitor stations selectively, you can set up a list of up to eight callsigns with the command **LCALLS**. The callsigns in this list are regarded as buddies," i.e., the only stations you want to listen to if **BUDLIST** is ON. Otherwise, the stations in the list will be ignored, and all other stations will be monitored.

You can have a group conversation with some data integrity by having the stations connect in pairs and setting **MALL ON** and **MCON ON**. This does not insure that every packet is received at every station, but it does insure that a packet involved in a collision will be retried. If you have an odd number of stations participating in this sort of conversation, one station can connect to itself via another station as digipeater.



Ordinarily, only text packets are displayed. If you desire to monitor all packet activity on frequency including all of the 'supervisory' frames that contain no user data, set **MCOM ON**. This allows every correctly received frame to be displayed. For example:

```
WA7GXD>KV7D <I C S0 R0>: Hi Dan,  
WA7GXD>KV7D <I C P S1 R0>: been on HF ?  
KV7D>WA7GXD <RR R F R2>  
KV7D>WA7GXD <I C P S1 R2>: no, 10 meters is dead.
```

The abbreviations are explained in the Protocol Chapter.

You can cause the packet controller to "filter" certain characters from monitored packets with the command **MFILTER**. This allows you to remove, for example, form-feeds, bell characters, or clear-screen characters that may be necessary to the stations involved in a connection, but which may interfere with the display. You can specify up to four characters by giving the ASCII character codes in hex or decimal. Refer to the ASCII Codes for Control Characters Table.

The **MONITOR** command controls the display of unconnected (Unnumbered Information or UI) frames when the packet controller is not in Transparent Mode. Monitoring is automatically disabled when in Transparent mode unless the **MTRANS** command is ON. The monitored callsigns, if shown, are separated by commas.

- **MONITOR = 0** disables monitoring.
- **MONITOR = 1** monitors all types of data frames but outputs no non-printable ASCII characters above 7F (decimal value 127).
- **MONITOR = 2** (equivalent to **ON** in older firmware) monitors all received frames.

The command **PIDCHECK ON** will eliminate the display of received frames whose Protocol Identifier (PID) is not \$F0. This should prevent most unwanted 'NODE' transmissions from being displayed.

### **"Health" Features**

The command **HEALED ON** will cause the CON and STA LEDs to turn on and off in a sequential pattern if the processor is properly executing the software. **HEALED OFF** restores the LEDs to their normal functions.

Twenty-five sixteen-bit counters are provided to monitor a number of parameters in the packet controller. They are ALWAYS initialized to 0000 on power up or **RESTART**. The counters and the setting of **HEALED** (HEALTH LED) are displayed in response to the command **DISPLAY**

**HEALTH.** The counters are defined in the Commands List Section of the Packet Controller Commands Chapter.

### Clock Operations

The packet controller clock is maintained in software by the microprocessor.

You enable the packet controller's real-time clock by setting the date and time with the command **DAYTIME**. Once you have set the clock, you request the time by entering **DAYTIME** with no parameters. The date and time will be lost each time the packet controller is powered off. The command **CLKADJ** is used to 'tweak' the software clock toward better accuracy. If the clock loses time, increase the value of the **CLKADJ** parameter, *n*. Large values have a small effect on the time, while small values of *n* have a large effect on the time.

Since the clock accuracy varies with the amount of activity on the radio channel, it may be impossible to get complete clock accuracy.

**NOTE:** Some PacComm packet controllers have an optional hardware clock which retains the date and time even if the packet controller is powered off.

The format of date and time display is controlled by the commands **DAYUSA** and **AMONTH**. **DAYUSA** allows selection of a US or international date format and **AMONTH** allows selection of alphabetic or numeric month format. The **AMONTH** command does not affect the date format of the Personal Message System.

### Time Stamping

Monitored packets can be time-stamped if **DAYTIME** has been set. To enable this function, set **MSTAMP ON**. You can also time-stamp connect and disconnect messages with the command **CONSTAMP ON**.

### Special Operations

If you are operating a full-duplex radio station (simultaneous transmit and receive), you should set **FULLDUP ON**. The packet controller is always electrically capable of full duplex operation, but this parameter causes the packet controller to ignore carrier detect status.

For satellite and other full duplex modes of operation you should set **DWAIT** to 0 and **ACKPRIOR OFF**. The random wait before retry transmissions can be disabled by setting **TXDELAY = 0**, **AXHANG = 0**, and using **AXDELAY** to set the required keyup delay.

### **Computer Operations**

The **BBSMSG** command is particularly useful when the packet controller is used with a host computer. When **ON**, the command causes all packet controller messages to either be suppressed or to begin on a fresh line.

The **RXBLOCK** command should be used when the packet controller is serving a host computer. **RXBLOCK** is designed for automated operations, such as packet bulletin board stations. It is intended to help such systems discriminate between data received from the connected station and packet controller-generated messages.

If unacknowledged data packets exist at the time of a disconnection, the packet controller will send all of these data packets as Unnumbered Information (UI) frames. To prevent the dumping of these frames over the air, set the command **TXUIFRAM OFF**.

The **STATUS** command is useful for allowing a host computer to obtain information about whether a connection exists, whether there are any unacknowledged frames, and whether a pending connection or disconnection exists.

### **HF Operation**

Some PacComm packet controllers are equipped with both VHF and HF optimized modems. See the Technical Reference Manual for a description of the controller's capabilities. Dual-modem boards have several additional commands to support HF operation.

The **PORT** command selects which radio port is in use. The **PORT** command causes most parameters except callsign to be changed to correspond with the use of the selected port, including the radio baud rate, modem tones, and link timing parameters. If the **PORT** command is given without an argument, the packet controller responds with the number of the currently selected port. If **PORT** is given followed by a port number such as:

**cmd: PORT 2**

the packet controller switches to the specified port and responds with the number of the previously selected port.

**PORT was 1**

**cmd:**

Only packet controllers termed 'DUAL PORT' in the Technical Reference Manual are capable of simultaneous operation of the radio ports. Dual-radio or dual-modem models disconnect the port not currently selected.

Some PacComm packet controllers allow selection of the carrier detect signal (DCD) from either the modem circuit (hardware) or a software algorithm (software). The command **SOFTDCD ON** selects the software type of DCD, while **SOFTDCD OFF** selects the hardware signal for DCD. Consult the Technical Reference Manual to determine if this command applies.

## **Remote Commanding**

---

The **REMOTE** command enables and disables the Remote Commanding feature, which allows complete setup and control of a packet controller over an RF link. The following definitions apply:

- ♦ *Remote TNC* is the TNC which will be controlled over the RF link.
- ♦ *Base TNC* is the TNC from which the operator sends commands to the Remote TNC.
- ♦ *Operator* is the person at the keyboard of the Base TNC.
- ♦ *Password* is the value stored in the Remote TNC in the **PASSWD** parameter.
- ♦ *Password Query String* is the authorization verification request from the Remote TNC to the Operator.
- ♦ *Response String* is the stream of characters sent by the Operator in reply to the Password Query String.

The Remote Commanding feature is implemented by the **REMOTE**, **RMTCALL**, and **PASSWD** commands.

- ♦ **REMOTE** enables or disables the Remote Commanding feature in the Remote TNC.
- ♦ **RMTCALL** is the command to enter the Remote Commanding callsign in the Remote TNC.
- ♦ **PASSWD** sets the password in the Remote TNC that is used in Remote Commanding operations.

**NOTE:** The first two commands above must be initially set from the terminal attached to the Remote TNC. Once set, the **REMOTE** command may be changed over the RF link. If you remotely set **REMOTE OFF**, and disconnect, then another remote connection may not be established. **PASSWD** may be set over the RF link. The **RMTCALL** (and the TNC's **MYCALL**) cannot be changed over the air.

When REMOTE is set ON and RMTCALL is set, a remote connection may be made to the TNC's RMTCALL to issue and view the output from TNC commands. All commands may be executed remotely except:

- No callsign changes for MYCALL or RMTCALL will be honored.
- PMS should not be accessed. Some PMS commands may function properly under these conditions, others may fail. The proper way to access all PMS commands is by connecting to the PMS callsign and using the Remote SYSOP function.
- You should avoid use of the DISPLAY command and instead use subsets of that command, such as DISP H, DISP T, etc. If you use the DISPLAY command you will get approximately 300 bytes of data and then nothing else. Sending a <CR> (empty frame) will restore the cmd: prompt.
- The HELP command (not available on all products) is subject to the same constraints as the DISPLAY command.

The PASSWD command is used to set the password in the remote TNC. If the PASSWD field is blank, then the TNC will function without any password protection. The default value of PASSWD is: PASSWORD. If this field is set over the RF link, the entire password must be sent and received in a single packet, in other words PACLEN must be greater than 80 for it to work.

When a connection is made to the remote TNC's RMTCALL callsign, the TNC selects five random letters from the stored password (PASSWD), and sends the Remote Operator a Password Query String which consists of five decimal numbers that correspond to the position of these letters in the stored password. The Remote Operator must respond with the corresponding five letters to gain access to the TNC.

If the correct Response String to the Password Query String is entered, the TNC will respond by sending a cmd: prompt. If an incorrect response is entered, the TNC will disconnect. The Response String may contain leading and trailing camouflage characters. However, the correct five characters must be included in the entered sting in the order specified by the Password Query String. *The password search is case sensitive.*

For example, if using the default password of PASSWORD, the Remote TNC might send a Password Query String of 01 08 05 06 02. The operator would enter PDWOA to gain access to the TNC. The operator may elect to append leading and trailing camouflage characters, if desired, and thus enter: oiJitPDWOAkjhNHCYfa and also gain access to the Remote TNC.

## Multiple Connections

With multiple connections, you may establish simultaneous connections with several stations, and the packet controller will keep the data to and from each connection segregated. The packet controller defaults the multi-connect-related parameters to the following 'single connection' values:

|                 |     |
|-----------------|-----|
| <b>CONPERM</b>  | OFF |
| <b>LCSTREAM</b> | OFF |
| <b>STREAMCA</b> | OFF |
| <b>STREAMDB</b> | OFF |
| <b>STREAMSW</b> |     |
| <b>USERS</b>    | 1   |

The key to enabling multiple connections is to set **USERS** to a value greater than 1. If **USERS** is not 1, the packet controller will allow multiple connections (as many as the value of **USERS**) to your station from other stations. In addition, Transparent mode will operate differently, in that incoming data will be prefixed with the current **STREAMSW** character and identifier (such as "A"). Thus, truly transparent operation is not possible while supporting multiple connections).

The **STREAMSW** character, defaulted to "|", should be set to a character you won't normally use. Note that this character may be set to a hex value between \$80 and \$FF. This may allow you to use 8-bit characters (**AWLEN 8**) if your terminal or computer is capable of generating such "characters." This could help prevent confusion in interpreting incoming data from other stations if they happen to send data that includes your selected **STREAMSW** character. When operating a single user MailBox (BBS) system or other host computer application, it is highly recommended that **STREAMSW** be set to \$00 (disabled).

Although not foolproof, enabling **STREAMDB** may also help in sorting out **STREAMSW** characters included in the received data from valid stream switches generated by your packet controller. **STREAMCA** should be especially helpful when manually operating a station using multiple connections. This command prefixes each new stream of data from the packet controller with the stream identification.

When in the Command Mode the stream may be switched by entering the **STREAMSW** character (default "|"), followed by a stream identifier ("A" through "J"), followed by the command you wish to give.

```
cmd: E C
| E Connect in Progress
cmd:
```

When in the Converse Mode, you may switch streams by entering the **STREAMSW** character (default "P"), followed by a stream identifier ("A" through "J"), followed by the data you wish to send to the station on that stream. See the example in the description of **STREAMCA** for an illustration of this. Note that the stream identifier must be in upper case (A through J) unless **LCSTREAM** is set to ON.

When the packet controller firmware contains the Personal Message System (PMS), stream K is used for PMS functions and is displayed as part of the **CSTATUS** command display.

### Personal Message System

The PacComm Personal Message System (PMS) is a self-contained message system contained in the EPROM along with the regular packet firmware. The PMS allows the packet controller to support all standard packet functions while simultaneously allowing messages to be entered or read by an over-the-air user. Approximately 12-15k of battery backed RAM is allocated for messages. Messages are retained when the packet controller is powered off.

The PMS features complete compatibility with current BBS message standards. Message headers are optionally generated to allow tracking of the message in the BBS system. Message headers may be edited to allow message re-addressing.

To improve operator convenience the PMS supports forwarding from, and reverse forwarding to the local (home) BBS. Automatic forwarding by the PMS is NOT supported to reduce channel congestion. If the PMS is installed on a PacComm controller that is equipped with a printer port, messages may be printed directly to the printer at keyboard command.

### PMS Configuration Commands

The packet controller operator is referred to as the PMS Sysop (system operator). The commands that the Sysop uses to configure the PMS are:

|                 |                 |
|-----------------|-----------------|
| <b>3RDPARTY</b> | <b>MSGROUTE</b> |
| <b>AUTOFWD</b>  | <b>MYPCALL</b>  |
| <b>CLKSET</b>   | <b>NODETEXT</b> |
| <b>HOMEBBS</b>  | <b>PMS</b>      |
| <b>KILONFWD</b> | <b>REMSYSOP</b> |
| <b>LOGONMSG</b> | <b>STEXT</b>    |
| <b>MSGHDR</b>   | <b>TKILLOK</b>  |

To enable the Personal Message System, set **PMS ON** and enter a callsign in **MYPCALL**. The callsign must **NOT** be identical to **MYCALL**, however the

same call letters may be used with a different **SSID**. Check with other PMS operators in the area to determine what **SSID** is normally used to identify personal BBSs.

If the Sysop desires to allow messages to and from other stations to be left on his PMS, set **3RDPARTY ON**. Setting **3RDPARTY OFF** will cause users to be prevented from leaving messages to other than **ALL** or the PMS callsign. The Sysop may address messages to any callsign regardless of the setting of **3RDPARTY**. **HOMEBBS** is used to set the callsign of the local BBS that forwards mail to your PMS. The PMS uses BBS forwarding protocol when sending messages to the **HOMEBBS**, but uses a user protocol for all other message transfers.

**HOMEBBS** <callsign> is used to set the callsign of the local BBS that forwards mail to your PMS. The PMS uses BBS forwarding protocol when sending messages to the **HOMEBBS**, and uses a user protocol for all other message transfers.

**CLKSET ON** allows the **HOMEBBS** to automatically set the packet controller to the correct time during a forwarding session.

**AUTOFWD** causes any messages entered by the sysop to be automatically marked for forwarding.

**KILONFWD ON** causes all messages that have been reverse forwarded to be deleted from the PMS to preserve memory capacity for incoming messages.

**NODETEXT** <text> command accepts a connect string for use by the **FNPMMS** command. This connect string is used by the local node to connect to the desired forwarding station.

**LOGONMSG ON** causes the standard PMS logon message to be sent:  
Logged on to (PMS Callsign)'s Personal Message System

If the Sysop does not desire the standard PMS logon message to be sent, then set **LOGONMSG OFF**.

A custom logon message of up to 80 characters may be entered in **STEXT** and will be sent each time that a station connects to the PMS. If **LOGONMSG** is **ON** and **STEXT** contains a message, both will be sent. If **LOGONMSG** is **OFF** and **STEXT** is blank, neither message will be sent. Note that if the GPS functions are enabled (**GPS ON**) then the **STEXT** field will be overwritten with the currently selected location string.

If you are using the reverse forwarding capability of the PMS, set **MSGHDR** to insert a message header in outgoing messages.



The **MSGROUTE** command allows reducing the size of stored PMS messages by eliminating lengthy lists of BBS routing history. PMS messages contain the complete BBS routing history which can often exceed the size of the message content. When **MSGROUTE** is ON, all lines of BBS routing history are retained in the PMS message. When **MSGROUTE** is OFF, only the first and last lines of the history are retained in the PMS message.

The **REMSYSOP** command set to ON causes the PMS to allow the same privileges (read or kill any message) to the sysop's callsign over the air as well as from the keyboard.

If you desire to allow any user of the PMS to have permission to kill NTS traffic messages, set **TKILLOK** to ON.

See the individual command descriptions in the Packet Controller Commands chapter for further information.

### **PMS Sysop Operating Commands**

The commands used by the Sysop to operate the PMS are:

|                |                |
|----------------|----------------|
| <b>EDITHDR</b> | <b>RFPMS</b>   |
| <b>FORWARD</b> | <b>RFPMS</b>   |
| <b>FPMS</b>    | <b>SB</b>      |
| <b>FNPMS</b>   | <b>SEND</b>    |
| <b>KILL</b>    | <b>SP</b>      |
| <b>LIST</b>    | <b>SR</b>      |
| <b>MINE</b>    | <b>ST</b>      |
| <b>PPRINT</b>  | <b>VERSION</b> |
| <b>READ</b>    |                |

Note that some of these commands take a different form than used by an over-the-air PMS user (below).

The Sysop may list all messages currently stored in the PMS by entering the **LIST** command at his computer keyboard. If only messages addressed to or from the sysop's PMS station (**MYPCALL**) are of interest, use the **MINE** command. Messages may be read by entering **READ n**, where n is the message number of interest. If the packet controller is equipped with a printer port, then messages may be sent direct to the printer attached to the packet controller with the command **PPRINT n**. Messages are deleted by the command **KILL**.

If any station has left a message in the PMS since the last time the Sysop accessed it, the PMS LED (STA LED on some models) will blink slowly to indicate that a message is waiting.

To send a message, use the command **SEND** or **SP**. Either command generates a private message. If the message is to be sent via the amateur packet BBS system, use the form of the command:

**SEND callsign @ bbs-callsign Soptional BID.**

The PMS supports the Bulletin ID (BID). A **BID** may be entered following the **TO** callsign field when using the **SEND** (or **SB** or **SP** or **ST**) command. The dollar sign character must be present, but the following field may contain up to 28 characters of any type.

In standard practice the Dollar sign is followed by a BID number, an Underbar character and a callsign. The line must terminate with a carriage return. An example of the BID format:

**SP N4UQQ @ K0ZXF \$53\_N4UQR**

The **BID** does not appear in the message display header in response to the **LIST** command but does appear in the presentation of each individual message in the following format:

Stat:  
Posted:  
To:  
BID:  
Subject:

The command **SB** is an alternate form of the **SEND** command that marks the message as a bulletin.

The command **SR** creates a reply message addressed to the sender of message **n**. The **@BBS** field is also generated as part of the address.

The command **ST** marks the message as official National Traffic System (NTS) traffic and the text of the message should be entered in NTS format.

If an error is made in entering the callsign header, or if a message is to be re-addressed, use the **EDITHDR** command to change the **TO** or **@** callsigns.

To mark a message for automatic reverse forwarding, use the command **FORWARD**. If a message is already marked for forwarding the command **FORWARD n** will "unmark" the message.

Marking messages for forwarding causes no forwarding to take place unless the **HOME**BBS connects to the PMS or the operator uses either the **FPMS** or

**FNPMS** command. The FPMS is used when the station is reached via a direct connection or via a digipeater string. The FNPMS is used in conjunction with **NODETEXT** when a node exists in the forwarding path.

You may force reverse forwarding to your packet controller of the mail in another PacComm PMS by using the **RFPMS** and **RFNPMS** commands. These correspond in usage to the FPMS and RFPMS commands respectively.

The **VERSION** command displays the packet controller sign-on message for verification of software release version, date, and features without powering the packet controller off and on.

See the individual command descriptions in the Command List chapter for further information.

**PMS User Commands**

The commands used by the over-the-air user of PMS are listed below:

| PMS User Commands | Corresponding PMS Sysop Commands |
|-------------------|----------------------------------|
| (B)YE             |                                  |
| (H)ELP            |                                  |
| (J)LOG            |                                  |
| (K)ILL            | KILL                             |
| (KM)              |                                  |
| (L)IST            | LIST                             |
| (M)INE            | MINE                             |
| (R)EAD            | READ                             |
| (SB)              | SB                               |
| (S)END            | SEND                             |
| (SP)              | SP                               |
| (SR)              | SR                               |
| (ST)              | ST                               |
| (V)ERSION         | VERSION                          |

All user commands consist of one or two letters that are shown in parenthesis. The commands with entries in the PMS Sysop Command column operate exactly the same as those Sysop Commands.

Use of more than the designated letters of the command will result in the message:

**[PMS CMD ERR]**

To use the PMS, the user simply connects to the PMS callsign. If PMS is ON and no other station is using the PMS, the following messages will be sent after the connection is established:

**\*\*\* CONNECTED TO (PMS callsign)**

**Logged on to (PMS Callsign)'s Personal Message System**

**This line may contain an optional custom PMS message (STEXT)**

**CMD(B/H/J/K/KM/L/M/R/S/SR/V/?)>**

**BYE** causes the user to be logged off from the PMS and disconnected.

**HELP** or **?** causes the PMS to send a 'one screen' list of command instructions.

**JLOG** causes a copy of the heard log to be sent to the user.

**KM** kills all messages addressed to or from the user's callsign.

See the individual command descriptions in the Command List chapter for further information.

## **Packet Radio Protocol**

---

The following material is intended to supply an overview of the protocol used to transmit data by the packet controller. It is somewhat tutorial in nature for those who have not had previous exposure to layered network protocols, but it presumes some knowledge of general communications hardware and software. Persons already well versed in networking may want to skip this chapter and refer to the primary defining document, Amateur Packet-Radio Link-Layer Protocol, AX.25 Version 2.0 available from the ARRL, 225 Main Street, Newington, CT 06111.

The PacComm packet controller hardware and software architecture is organized in accordance with the International Standards Organization (ISO) layered network model. The model describes seven levels and is officially known as the ISO Reference Model of Open Systems Interconnection, or simply the ISO Model. Andrew S. Tanenbaum discusses the model and many other interesting topics in Computer Networks.

The ISO model provides for layered processes, each supplying a set of services to a higher level process. The PacComm packet controller currently implements the first two layers, the Physical layer and the Data Link layer.

### **Physical Layer**

---

The duty of the Physical Layer, layer one, is to provide for the transmission and reception of data at the bit level. It is concerned only with how each bit is physically transmitted, i.e., voltages on a cable or modem tones on phone or RF links.

The physical layer of the packet controller is described in the Technical Reference Manual. It is compatible with the various packet controllers currently available. The actual 1200 baud modem interface is compatible with the Bell 202 standard which is similar to the CCITT V.23 standard. Any other hardware device, which is compatible with the Bell 202 standard, should be compatible with the PacComm 1200 baud packet controller, at least at level one of the ISO reference model.

### **Data Link Layer**

---

The duty of the Data Link layer is to supply an error-free stream of data to higher levels. Since level one simply passes any bits received to level two and is unaware of the content or overlying structure of the data, transmission errors are not detectable at level one. Level two carries the responsibility of detecting and rejecting bad data, re-transmitting rejected data, and detecting the reception of duplicate data.

Level two accomplishes this task by partitioning data to be transferred by level one into individual frames, each with its own error detection field and frame identification fields. The packet controller supports two versions of a level-two layer, AX.25 Version 1.0 and AX.25 Version 2.0. Each of these protocols is based on HDLC, the High-Level Data Link Control protocol defined by the ISO. Version 1 is supported for compatibility with older packet controllers only.

## **HDLC Frames**

---

| **FLAG** | **ADDRESS** | **CONTROL** | **PID & DATA** | **FCS** | **FLAG** |

**FLAG** is a unique bit sequence (01111110) used to detect frame boundaries. A technique called "bit stuffing" is used to keep all other parts of the frame from looking like a flag.

**ADDRESS** is a field normally specifying the destination address. AX.25 uses a minimum of 14 bytes and a maximum of 70 bytes containing the actual call signs of the source, destination, and optionally up to eight digipeaters.

**CONTROL** is a byte which identifies the frame type. In the AX.25 protocol, the control field may include frame numbers in one or two 3-bit fields.

**PID** is a Protocol Identification byte that appears as the first byte of the HDLC **DATA** field in AX.25 Level Two information frames, and identifies which Level 3 protocol is implemented, if any. In the case where no Level 3 protocol is implemented, PID = \$F0.

**DATA**, this field contains the actual information to be transferred. This field need not be present. Most frames used only for link control do not have data fields.

**FCS**, (Frame Check Sequence), a 16-bit error detection field.

The communications chip recognizes the opening and closing flags and passes the address, control, and data (including PID) fields to the software. The FCS field is a Frame Check Sequence computed by the transmitting chip and sent with the frame. The receiving chip re-computes the FCS based on the data received and rejects any frames in which the received FCS does not match the computed FCS. There is virtually no chance of an undetected bad frame using this method. This satisfies the level two task of bad data detection. The circuitry used in the packet controller encodes the transmitted data in NRZI form, which encodes a "0" data bit as a transition in the encoded bit stream and a "1" data bit as no transition. This, in combination with the "bit-stuffing"

which ensures that no more than five "1"s occur in a row except when FLAG bytes are being transmitted, guarantees that a logic level transition occurs at least once every 5 bit times. These frequent transitions allow the receiver to synchronize its clock with the transmitter.

While the HDLC format supplied by the communications chips is used by the AX.25 protocol, there are several other Layer Two concerns. These are duplicate frame detection, connection and disconnection of the level two layers on different packet controllers, and buffer overrun avoidance. The AX.25 protocol solves these problems as described below.

### **AX.25 Level Two**

AX.25 is based on the Balanced Link Access Procedure (LAPB) of the CCITT X.25 standard. LAPB in turn conforms to the HDLC standard. Two extensions are made to LAPB in AX.25. These are the extended address field and the unnumbered information (UI) frame. In LAPB, addresses are limited to eight bits, while AX.25 uses from 112 to 560 bits, containing the originator's call sign, the destination call sign and an optional list of one to eight digipeater (simplex digital repeater) call signs.

The UI frame is used to send information bypassing the normal flow control and acknowledgment protocol. The UI frame is not acknowledged but can be transmitted at layer two without fear of disturbing higher layers. It is used for beacon frames, for automatic identification packets, and for sending information frames when the packet controller is not connected to another packet controller.

The following table lists the frame types used by AX.25 and describes their purpose. This material is provided to give a general understanding of the protocol, and is not intended to replace the published specification. The byte fields are given as they appear in memory after data is received, i.e., the high order bit is at the left and the low order bit is at the right. This is also the format of the display provided by the TRACE command. Some texts, including the AX.25 protocol specification, list the bits in the order in which they are transmitted, which is low order bit first.

The table also lists the format of the display of the interpretation of the MCOM command byte in each monitored frame when MCOM is turned ON. The basic structure of the MCOM information is:

**< cmd\_type [(C|R) (P|F)] [Sn] [Rn] >**

The "<" and ">" characters are always present, and serve to delimit the new MCOM information. Cmd\_type may take any of the values in the right column of the table.

- **C|R, P|F** The C(ommand), R(esponse), P(oll) and F(inal) frame types are only used in AX.25 level 2 Version 2.0 mode. These types are not displayed for packets not using Version 2.0.
- **Sn** is displayed for sequenced information (I) frames. 'n' is the frame's sequence number and is an integer 0..7.
- **Rn** is present in both I frames and RR-RNR-REJ frames. The 'n' value monitored shows the sequence number that the sending station expects its peer will use for the next new sequenced information frame.

The control bytes are presented in hex with "x" used to indicate four bits which depend on the acknowledge functions the packet is performing. Usually "x" is a frame number. Frame numbers fit into three bits and are used to ensure that frames are received in order and that no frames are missed. Since only three bits are available, the frame number is counted module 8. The MAXFRAME parameter has a ceiling of 7: no more than seven frames can be transmitted but remain unacknowledged at once.

| Code | Abbreviation | Frame Type  |
|------|--------------|---|
| x1   | RR           | Receive Ready   |
| x5   | RNR          | Receive Not Ready   |
| x9   | REJ          | Reject  |
| 03   | UI           | Unnumbered Information  |
| 0F   | DM           | Disconnected Mode   |
| 2F   | SABM         | Connect Request   |
| 43   | DISC         | Disconnect Request  |
| 63   | UA           | Unnumbered Acknowledge  |
| 87   | FRMR         | Frame Reject  |
| even | I            | Any frame ending in an even number (including \$A, \$C, and \$E) is an information frame. |

- **I** This and UI frames are the only frame types containing user data. The control byte contains this frame's number, and the number of the next frame expected to be received.



- **RR** Usually used to acknowledge receipt of an I frame. The RR function can also be performed by sending an I frame with an undated "expected next frame number" field.
- **RNR** Used when the buffer space on the receiving side is full.
- **REJ** Used to request retransmission of frames starting from "x". Missed frames are detected by receiving a frame number different from that expected.
- **DM** Sent in response to any frame received other than a connect request (SABM) when the packet controller is disconnected. Sent in response to an SABM whenever the packet controller can't connect to the requesting user, e.g., if the packet controller is already connected or CONOK is OFF.
- **SABM** Set Asynchronous Balanced Mode - initiates a connect.
- **DISC** Initiates a disconnect.
- **UA** Sent to acknowledge receipt of an SABM or DISC.
- **FRMR** Sent when an abnormal condition occurs, i.e., the control byte received is undefined or not proper protocol at the time received.
- **UI** An I frame without a frame number. It is not acknowledged.

### **Channel Use and Timing**

An important part of any packet radio protocol is the means by which many stations make efficient use of an RF channel, achieving maximum throughput with minimum interference. The basis for this time domain multiplexing is Carrier-Sensed Multiple Access (CSMA) with collision detection and collision avoidance.

CSMA means simply that no station will transmit if the frequency is in use. The packet controller continually monitors for the presence of packet frame flags on frequency and transmits only if there is no activity present. In order to make detection of a busy channel more reliable, the packet controller sends an audio signal (continuous flags) any time the transmitter is keyed and a packet is not being sent, as during the transmitter keyup delay (TXDELAY), or while a slow audio repeater is being keyed (AXDELAY).

By itself, CSMA is not enough to insure a minimum, or even low, interference rate, due to the likelihood of simultaneous keyup by two or more stations. This is where collision detection and collision avoidance come in. The packet

controller detects a collision by the absence of an ACK from the station it is sending to. The receiving station does not acknowledge the frame that suffered the collision, since either the FCS was incorrect or the packet was not heard. There are other possible reasons for non-receipt of the packet, but the packet controller's response is based on the assumption of a collision.

After transmitting a packet, the packet controller waits a "reasonable" length of time (FRACK) for an acknowledgment. "Reasonable" is determined by the link activity, frame length, whether the packet is being digipeated, and other time-related factors. If no ACK is received, the packet must be re-sent. If the unACKed frame was lost due to a collision, the assumption is that there is at least one other packet station out there that also lost a frame and will probably have exactly the same criterion for deciding when to retry the transmission as this station is using.

In order to avoid a second collision, the collision avoidance protocol calls for the stations retrying transmissions to wait a random time interval after hearing the frequency become clear before they key their transmitters. There must be enough different random wait times to provide a reasonable chance of two or more stations selecting different values. The difference between adjacent time values must be similar to the keyup time delay (TXDELAY) of typical stations on the frequency. The random time is a multiple (0-15) of the transmitting station's keyup delay (TXDELAY). This is reasonable if one's own keyup delay is similar to that of other stations on the channel.

The above frame retry timing technique does not address the collisions which occur when a packet controller attempts to access the channel for an initial transmission. On a lightly loaded channel, the simple procedure of listening for a clear channel before an initial transmission successfully interleaves most transmissions. On a heavily loaded channel, however, an increasing source of collisions comes from the reservoir of stations monitoring the channel for an initial transmit opportunity. Once the channel clears, numerous stations immediately "jump on the channel."

To reduce this problem, several alternative channel access methods have been incorporated in the currently provided firmware. These alternative methods of channel access attempt to reduce the number of collisions and thus improve channel throughput. When enabled, these alternate timing methods also are used to control retry timing. Either of the alternate timing methods may be enabled in place of the traditional techniques described above.

Both alternate techniques apply randomness to the initial channel access. When a frame needs to be transmitted, the channel is monitored to see if it is available. If available, a gaming algorithm is applied to determine if the free channel opportunity will be exploited.

P-Persistence access timing uses two parameters, PERSIST and SLOTTIME, to specify aggressiveness in initially accessing the channel and in subsequent retransmission attempts.

PERSIST is a threshold setting which is applied to a random number between 0 and 255 generated when a frame needs to be sent. If the random value is greater than the PERSIST value, no transmission is made. If the random value is less than or equal to PERSIST, an attempt is made. A value of 127 equates to a 50% probability that channel access will be attempted. Persist = 255 provides 100% probability of attempting to seize the channel. The default value of 200 provides approximately an 80% probability.

SLOTTIME selects the length of the delay between generating random numbers as part of the PERSIST transmit timing. Larger SLOTTIME values lower the packet controller's priority in accessing the channel.

The T-Persistence slotting technique is functionally equivalent to the P-Persistence technique, but the parameters are defined in different terms. SLOTS specifies the number of "slots" from which to choose when deciding to access the channel. SLOTS is roughly equivalent to the PERSIST parameter. Effectively, slots are the inverse of the probability of channel access, i.e. SLOTS = 2 is equivalent to a 1/2 or 50% channel access probability. DEADTIME is the time between attempts to access the channel. This is equivalent to the SLOTTIME parameter in the P-Persistence technique.

One other factor must be taken into consideration in optimizing data throughput. The currently implemented link protocols provide for relaying (digipeating) of packets. The acknowledgment procedure for such packets is that the relay station simply repeats packets without acknowledgment to the sending station. The receiving station sends its ACK back through the same digipeaters to the originating station. Since the digipeated packets are not acknowledged to the digipeater, an unsuccessful transmission must be retried from scratch by the originating station. In order to help alleviate the congestion of the frequency that tends to result when digipeated packets suffer collisions, the digipeater is given first shot at the frequency every time it becomes clear. Other stations, instead of transmitting as soon as they hear the channel clear, *must wait* a short time (DWAIT). This restriction applies to all stations except the digipeater, which is permitted to transmit relayed packets immediately. This prevents digipeated packets from suffering collisions except on transmission by the originating station.

A special time delay (RESPTIME) is used as the minimum wait time prior to transmitting acknowledgment frames, to prevent packet controllers accepting data at high speed from the asynchronous port from colliding with

acknowledgment frames when fewer than MAXFRAME packets are outstanding. The receiving packet controller will wait long enough before sending the ACK so that it will hear the data packet which would have caused the collision, thus avoiding a fairly frequent source of delay in versions of AX.25 prior to 2.0.

Finally, priority acknowledgement (ACKPRIOR) may be activated with any of the channel access timing methods. When a frame is transmitted which requires an acknowledgement is heard, the packet controller with priority acknowledgement enabled will wait an adequate time for the acknowledgment to take place, even if the acknowledging station cannot be heard.

### **Channel Flow Control**

Flow control of data through the link is determined by the rate at which data is being supplied to a sending packet controller and accepted from a receiving packet controller.

A packet controller receiving data from the link will send an RNR when the next I frame successfully received will not fit into the buffer for output to the serial port.

Whenever a packet controller transmitting data received from the serial port over the link runs out of temporary buffer space, an XOFF character or CTS signal will halt the serial port. In one packet controller model implementation this happens whenever there are 7 packets built and less than 210 characters left in the buffer for input from the serial port.

When the packet controller receiving data from the link clears out its buffers, it sends an RR to the transmitting packet controller. In order to guard against the possibility of the RR being lost and the link becoming permanently locked, the transmitting packet controller will periodically re-transmit the packet that provoked the RNR. The receiving packet controller will continue to respond with RNR until it can accept the packet.

Pico Packet Radio Cable Pin-Out

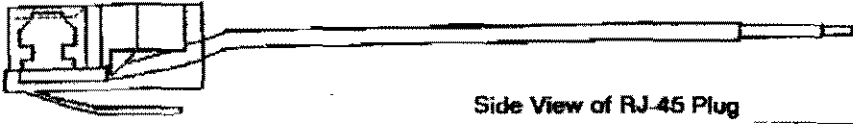
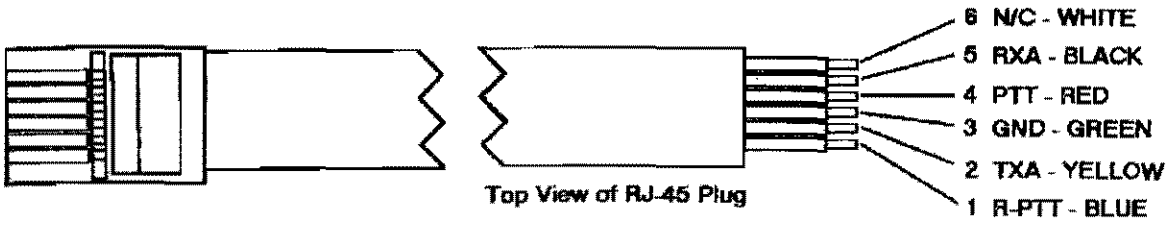

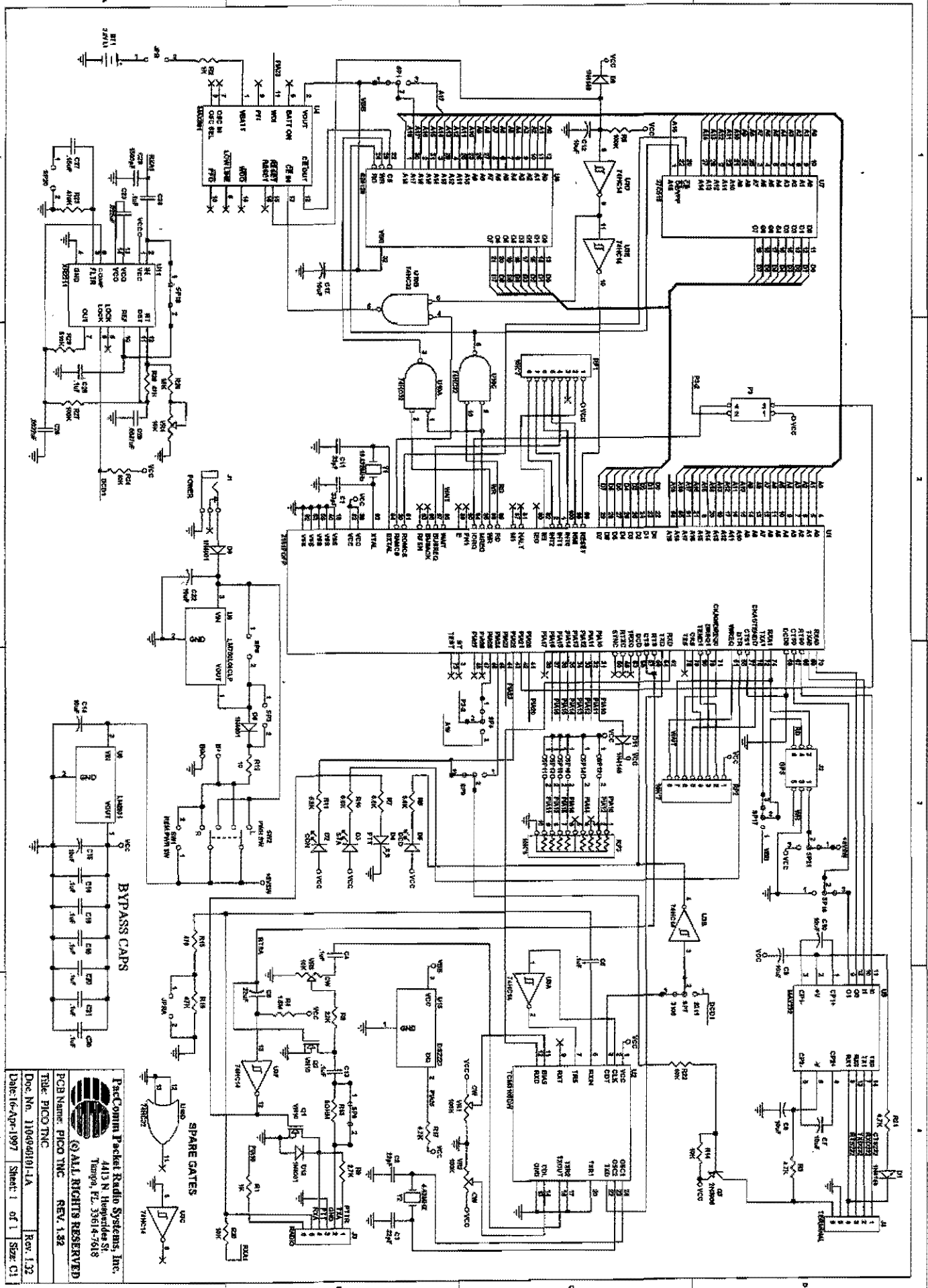

**PacComm Packet Radio Systems, Inc.**  
 4413 N. Henderson St.  
 Tampa, FL 33614-7618  
 © ALL RIGHTS RESERVED  
 PCB Name: PICO TNC REV. 1.32  
 Title: PICO TNC  
 Doc No. 110694010-1A Rev. 1.32  
 Date: 6-Apr-1997 Sheet: 1 of 1 Size: C1

**Parts List**

- (1) 3' Section of BLACK 28 Gauge Wire (WR-28GS-BLK)
- (1) 3' Section of BLUE 28 Gauge Wire (WR-28GS-BLU)
- (1) 3' Section of YELLOW 28 Gauge Wire (WR-28GS-YEL)
- (1) 3.5mm STEREO Phoneplug (PLUG-3.5-STEREO)
- (1) 4" Section of 3/32" Heatshrink (HSHRK-332)

Cut the heatshrink into 1/4" sections and place them approximately every 2" along the length of the wires to bind them together. Strip and tin approximately 1/4" at the end of each individual wire.

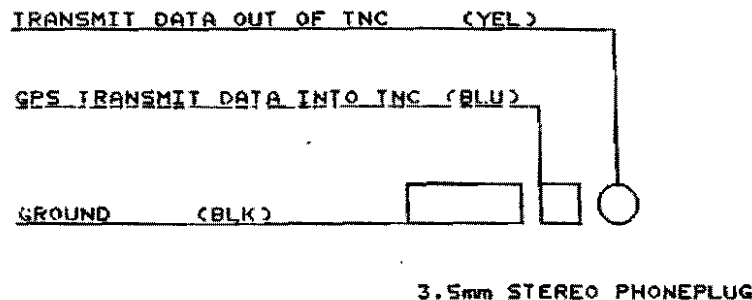

THIS CABLE IS SUPPLIED WITH EVERY PicoPacket THAT IS SOLD WITH A 2nd SERIAL PORT.

THIS CABLE IS SUPPLIED WITH EVERY PicoPacket SOLD WITH A COMPANION GPS.

P1  
3.5mm STEREO Phoneplug

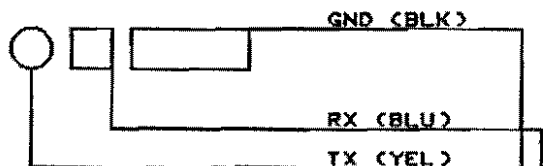

P2  
3.5mm STEREO Phoneplug

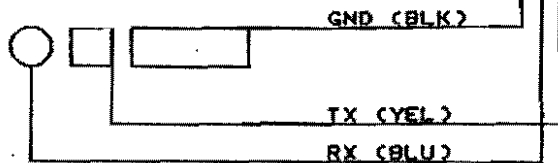

**Parts List**

- (2) 3.5mm STEREO Phoneplug (PHONEPLUG-3.5-STEREO)
- (1) 8" Section of BLACK 28 Gauge Wire (WR-28GS-BLK)
- (1) 8" Section of BLUE 28 Gauge Wire (WR-28GS-BLU)
- (1) 8" Section of YELLOW 28 Gauge Wire (WR-28GS-YEL)
- (1) 8" Section of 3/32" Heatshrink (HSHRK-332)

Feed wires through the heatshrink and wire each end to a phoneplug as shown. DO NOT HEAT THE HEATSHRINK.

PacComm Packet Radio Systems, Inc.  
4414 N. Hesperides St.  
Tampa, FL 33614-7616  
(C) — ALL RIGHTS RESERVED

|                                      |                           |              |
|--------------------------------------|---------------------------|--------------|
| Title                                |                           | REV          |
| PicoPacket 2nd Serial Port/GPS Cable |                           |              |
| Size                                 | Document Number           | 1.0          |
| A                                    | 951103-0ICUB12UGULDVB-01A |              |
| Date:                                | November 7, 1995          | Sheet 1 of 1 |